

Titan Control Software

User Manual

(for TCS v3.3.23)

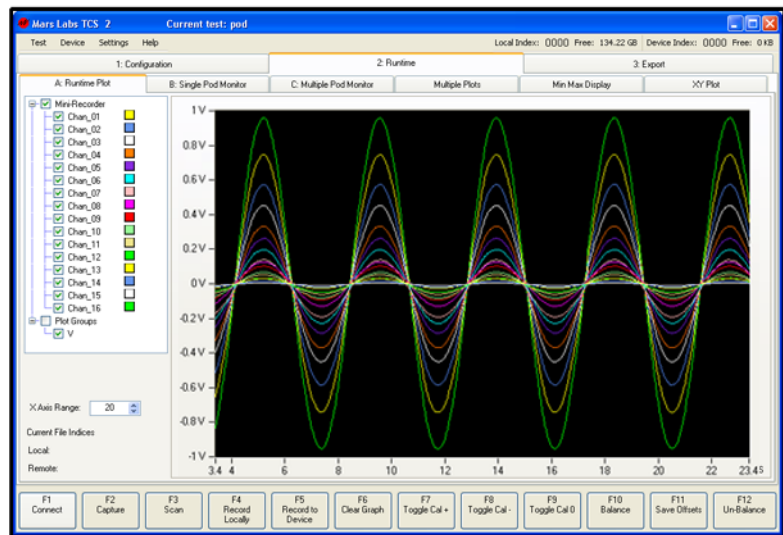

Proprietary Notice

This information is furnished for installation, operation, test and maintenance purposes. The information is proprietary in nature and should be treated accordingly. The data shall not be released or used, duplicated or disclosed, in whole or in part, for manufacture or procurement without the written permission of **Mars Labs**.

Copyright

This Technical Manual is copyright © 2024. All rights reserved. Brief excerpts may be made from this manual for technical purposes, as long as they are referenced.

Although this manual is believed to be correct at the time of publication, **Mars Labs**, its employees, or agents involved in the preparation and publication of this manual do not accept any form of liability for its contents or any consequences arising from its use. People using the information contained in this manual should apply, and rely upon, their own skill and judgement to a particular issue which they are considering.

Titan Control Software User Manual v13.4
MNL 1001
January, 2024
(covers TCS version 3.3.23)

Bookmarks and hyperlinks added
for PDF viewing

Table of Contents

Introduction

Getting Started	6
Requirements	6
Support	6

Starting Up

Software Installation	7
Pod/Mini-Recorder Device Configuration	10
CPU Device Configuration	11
DAC Device Configuration	13
Configuration: The Sensors Tab	14
Configuration: The Tags and Channels Tab	16
Configuration: The Recording & Triggers Tab	17
Runtime Tab	18
Export Tab	26

Advanced Settings

Configuration Tab	39
Device Configuration - Mini-Recorder	39
Device Configuration - Titan CPU Channel Expander.....	45
Device Configuration - Titan CPX Expander	48
Sensors - Analog	50
Sensor Types	51
Acceleration	52
Digital	54
Displacement	55
Load	56
Other - Sensitivity	57
Other - Polynomial	58
Pressure	59
Strain	60
Thermocouple	61
Voltage	66
Physical Calibration (PCAL)	68
Sensor Import/Export	72
Sensor Import	73
Sensor Export	78
Sensors - Digital	80
Managing CAN Channel Definitions	82
Configuring CAN Port Sources	83
ISO CAN	84
Wheel Force Transducer	86
J1939	87
GPS	89
Serial Port	89
Tags and Channels	90
Pseudo Channels	94
Recording & Triggers	100
File Controls	102
TCS Triggers	104

Table of Contents (cont.)

Advanced Settings	
Runtime Tab	110
Runtime Plot	110
The Capture Function	112
The Plot Groups Function	113
Single Pod Monitor	114
Multiple Pod Monitor	115
Multiple Plots	116
Min Max Display	117
XY Plot	117
GPS Display	118
Digital Pod Display	119
IMU Display	119
WFT Plot/WFT Display	119
Export Tab	120
Export and Review	120
Error Logs	121
Error Logging	121
Error Directory	122
Multi-Plot Review	124
Browse Remote Files	125
TCS File Definitions	126
File Renaming	127
TCS Menus	128
In-Vehicle Display	134
Test Control	134
Plot	136
Digital Display	137
Customizing the In-Vehicle Display	138
Launching into the In-Vehicle Display (Auto-Launch)	139
Loading from an Existing Test	140
Running with RS-422 (COMM)	142
Baud Rate considerations using the COMM Port	143
ICD Baud Rate Commands	144
Asset Tag and Customer Information Data Entry	146
Troubleshooting	148
Notes & Known Issues	152
Titan Service Pack	159

Table of Contents (cont.)

Appendix A: Power and Sensor Configurations for Titan Pod and Mini-Recorder Hardware	160
Auxiliary Power Connector	160
Full Bridge Sensor	161
Half Bridge Sensor	162
Quarter Bridge Sensor	163
Voltage Sensor	164
String Pot Sensor	165
RVIT Sensor	166
Frequency Sensor - Generator	167
Frequency Sensor - Switch Closure	168
Thermocouple Sensor	169
ICP Sensor	170
Dytran Accelerometer	171
Microphone (Condenser)	172
Appendix B: Scan Rates and Supported Configurations	173
Appendix C: Changing the CAN Mode	176
Appendix D: TCS Changelog	178
Appendix E: Titan Firmware Changelog	182
Appendix F: Acknowledgements	184

Notes on this User Manual:

1. The PDF version of this User Manual contains hyperlinks that permit quick access to referenced sections. Hyperlinks are indicated by a blue rectangle around referenced text:

See Voltage Sensor configurations (pg 154)

2. Where cited, function keys are indicated in brackets: **[F1]**

3. Some TCS configuration screens feature blue Helper Icons: 

Helper Icons are clickable links to targetted topics in the TCS User Manual where additional configuration information can be found. Clicking on a Helper Icon launches the TCS User Manual and opens to the relevant section.

Introduction

Titan Control Software (TCS) is a license-free software application that provides for the configuration, acquisition, display, and storage of sensor data from Titan data acquisition devices. TCS allows you to easily configure and control up to 16 channels of sensor data from a Titan Input Module and up to 192 channels from a 12-port Titan CPU Channel Expander. Acquired data can be displayed graphically or in numerical form in real-time, and can be exported in a variety of common file formats.

This manual provides an overview of TCS with complete feature descriptions, specifications, installation and setup procedures, and operational information.

Getting Started

This manual will take you through the steps to configure TCS to work with your Titan data acquisition device. The Starting Up section should be followed first to install TCS and get the Titan hardware properly connected and running with the TCS application. Detailed information about TCS windows and features appears in the Advanced Settings section that follows. Power and sensor configurations appear in Appendix A.

Requirements

TCS is a standalone application designed to run on Windows operating systems with the Microsoft .NET Framework installed. The Microsoft .NET Framework installer is supplied on the TCS installation disc.

The TCS application requires:

- 100 MB Hard Drive space
- 512 MB RAM (min.)
- 1024 x 768 minimum screen resolution
- Two (2) USB 2.0 ports
- Adobe Acrobat Reader (to view embedded PDF documentation)
Application available at www.adobe.com/products/acrobat

A 2.4G Pentium 4 or faster PC is recommended for the best performance.

Support

Support for this product is available by contacting the factory during normal business hours (9am – 6pm EST) at 301-470-3278. Additional information can be found on our web site: <http://www.marslabs.com>

Starting Up

This chapter describes the steps to install, connect and configure the TCS application with the Titan Pod/Mini-Recorder, Titan CPX Channel Expander, and Titan DAC.

Software Installation

1. Install the TCS software from the supplied CD-ROM disc or downloaded from the Mars Labs Knowledge Base (filename: 'TCS3_setup_X.X.X.exe')

Windows XP users will also need to install the Microsoft .NET software framework (filename: "dotnetfx35.exe").

NOTES:

1. *Installation of the .NET framework is only required for Windows XP systems. It is not needed for Windows 7 & 8 systems.*
2. *Windows10 users should install TCS as described below*

Due to changes in Windows10, the standard installation of Titan Control Software (TCS) may not function correctly. Windows10 users should install TCS by right-clicking on the TCS installer icon and selecting 'Run as Administrator', and then follow the prompts to install TCS. When the installation is finished, a modified TCS3 shortcut icon will appear on the desktop. Double-clicking the icon will produce a dialog box asking if you want to allow the application to run on the machine:

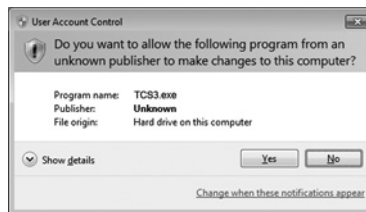

Click 'Yes', and TCS will launch and function normally.

Note that this dialog box will appear every time TCS is launched. Mars Labs is currently working on an update to address this issue.

If TCS is already installed on your Windows10 PC:

1. Right-click on the TCS icon and select "Properties".
2. Switch to the 'Compatibility' tab.
3. Check the box labeled "Run as Administrator"
4. Click "Apply", and then close the window.

2. Install the TCS application (filename: "TCS3_setup_X.X.X.exe"). The filename will include the current version number of TCS. Once installation is complete, the TCS application can be found in the Mars Labs file in the directory. The installation will also add two shortcut icons on the desktop:



TCS3

The standard installation of TCS



TCS3 Demo
Mode

A demo version of TCS with a simulated input (virtual hardware). For information on running the demo, double-click on the icon and view the 'Titan Control Software Demo Mode User Guide'

- 3a. If you are using a Titan Mini-Recorder, connect the device to the PC using a USB cable. The PC may prompt that a new hardware device has been found; proceed with the on-screen instructions and install the Titan USB driver if needed. **For assistance with the USB driver installation, see the Troubleshooting section at the end of this document.**
- 3b. If you are using a Titan CPU Channel Expander, connect the device to your network but do not apply power. Using standard Ethernet cabling, make all system connections before applying power.

NOTE: For an eight channel CPU, connect Titan Mini-Recorders starting with the lowest numbered ports first.

4. Launch the standard version of the TCS application. The first time TCS is run, the following message window will be displayed:

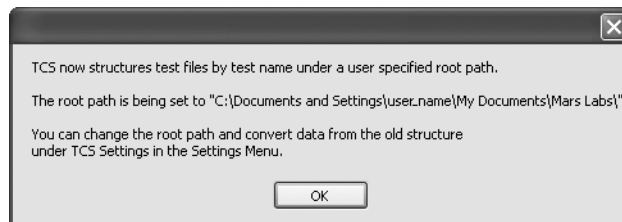

The message informs that TCS data files are exported under the specified test name to the displayed root path. You can change the root path, as well as convert data taken in previous versions of TCS to the new structure, under the 'Settings' menu.

Click 'OK' to dismiss the message window and continue with the installation.

NOTES:

1. The root path is also displayed in the TCS window title bar.
2. For more information on Root Path, Export Path, and Data Conversion, see the TCS Menus section.

6. You will be prompted to create a new test or load an existing test:

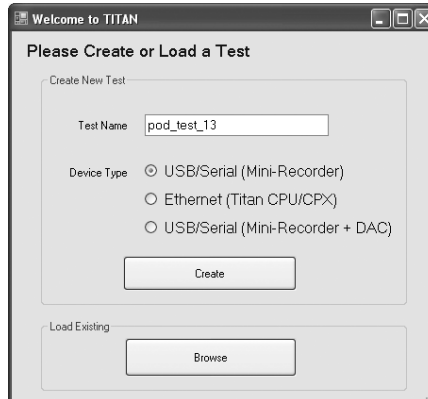

For a Titan Mini-Recorder or Pod, click on the ‘USB/Serial (Mini-Recorder)’ button.

For a CPU Channel Expander system, click on the ‘Ethernet (Titan CPU/CPX)’ button.

For a Mini-Recorder with a Titan DAC, click the ‘USB/Serial (Mini-Recorder+DAC)’ button.

TCS assigns a default test name that is based on the selected device and the current date. To change the name, click inside the Test Name field and enter a new name. All data taken during this session will be exported using the assigned test name.

After selecting the device type and test name, click ‘Create’ to begin configuring the test.

NOTES:

1. Test names cannot contain spaces

2. In this window, you also have the option of loading an existing test. Click on the ‘Browse’ button and navigate to the location of the desired test (valid test files have either a ‘.tcf’ or ‘.tdf’ extension). After selecting the file, clicking ‘Open’ (or simply double-clicking on the file) will load/import the file into TCS. For more information, see “Loading from an Existing Test”, page 139.

Pod/Mini-Recorder Device Configuration

After creating a test, TCS will display a ‘Device Configuration’ window which shows the test name and root path in the title bar. The next step is to select a device from the ‘Select Port’ list and then click the ‘Connect’ button [Function key F1]. If no ports appear in the list, click on the ‘Query Serial Devices’ button to check for connected hardware.

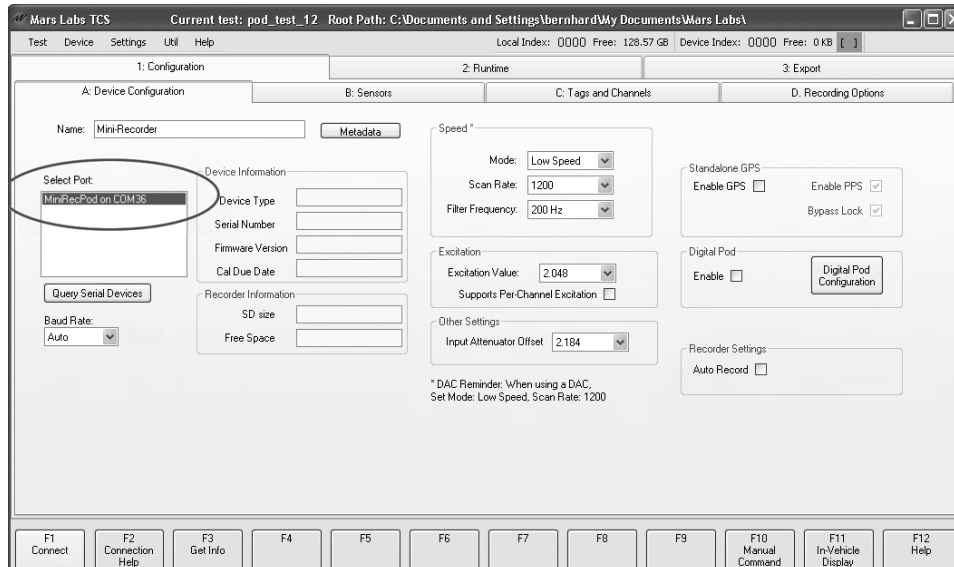

Once connected, the ‘Device Information’ and ‘Recorder Information’ panes will be filled with information about the connected Titan hardware. To complete the basic device configuration, select the speed of the device (High/Low), the desired scan rate, and the filter frequency. For complete information on all Device Configuration screen options, see Advanced Settings, pg 39).

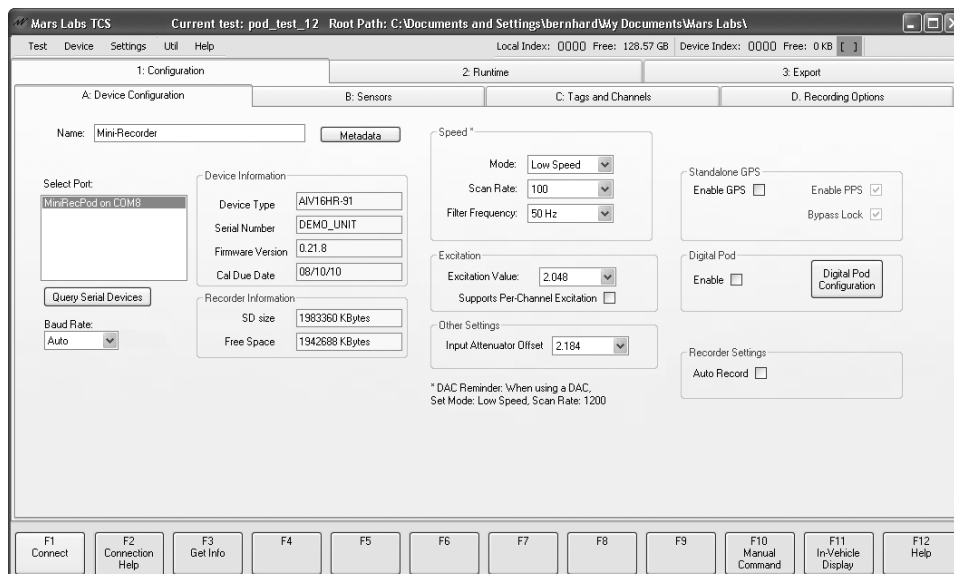

CPU Device Configuration

After creating a test, TCS will launch and display a ‘Device Configuration’ window which shows the test name and root path in the title bar. The first step is to select the network address of the connected CPU device. This address is posted on the CPU hardware; it should appear in the ‘Select Port’ field in TCS. If the address does not appear, click on ‘Find CPUs’. After the ‘Select Port’ field updates, select the correct address and then click ‘Connect’ [Function key F1] to connect to the CPU:

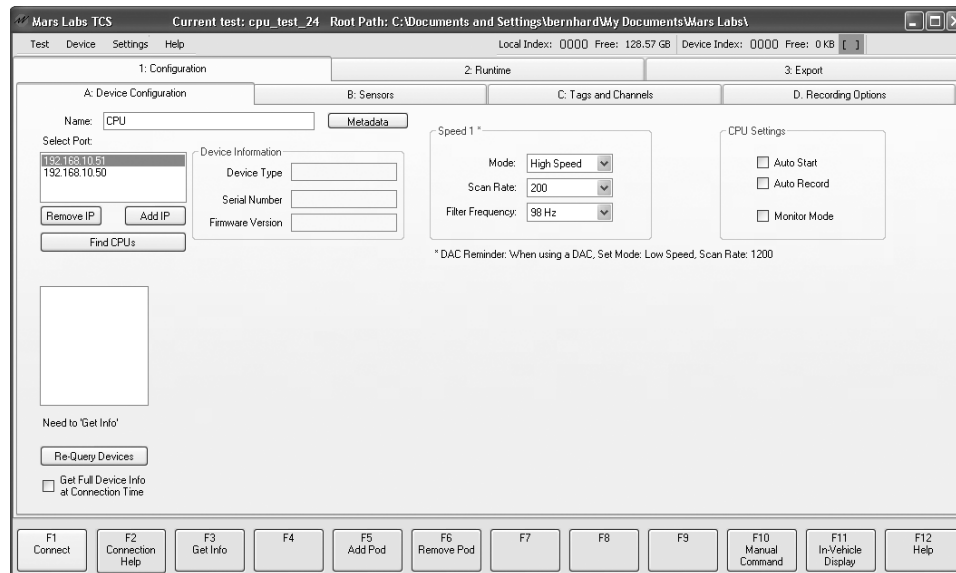

After connections are established, the ‘Device Information’ fields will display information about the connected Titan hardware, as shown below. To complete the device configuration, select the desired scan rate and the filter frequency of the CPU from the drop-down menus. The selected speed, scan rate and filter frequency will be applied to all connected Titan devices.

NOTES:

1. Users should heed the warning about mixing Titan device types. For more information see *CPU Configuration Issues in a Mixed Titan System*, pg 152
2. If the CPU is configured for High Speed operation when Low Speed Titan Pods or Mini-Recorders are connected, an error will result.
3. If a Titan DAC is part of the system configuration, select Low Speed mode with a 1200 Hz Scan Rate.

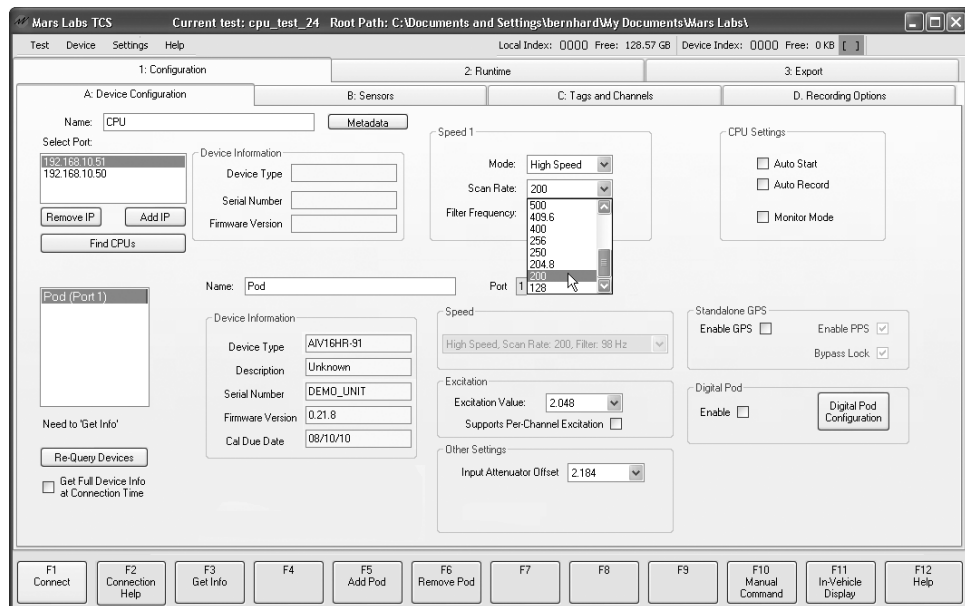

A Titan CPU supports up to 8 Titan Pods and/or Mini-Recorders. Titan devices can be added or removed from the Titan CPU as needed, but any new devices are not automatically detected. If you wish to add additional Titan Pods or Mini-Recorders after the initial configuration (the Titan CPU auto-detects devices only upon power-up), make the connections and then click on the ‘Re-Query Devices’ button. The Titan CPU will scan all ports for new devices, and TCS will display a status message during the process:

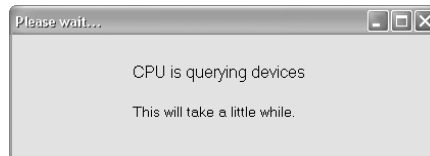

All connected Titan devices will be detected and appear in the device list in TCS.

For complete information on all Device Configuration screen options, see *Advanced Settings*, pg 45.

After completing the basic setup, continue to the *Sensors* configuration section.

DAC Device Configuration

After creating a test as described above, TCS will display a ‘Device Configuration’ screen which shows the test name and root path in the title bar. Select a device from the ‘Select Port’ list and click the ‘Connect’ button. If no ports appear in the list, click on the ‘Query Serial Devices’ button to check for connected hardware.

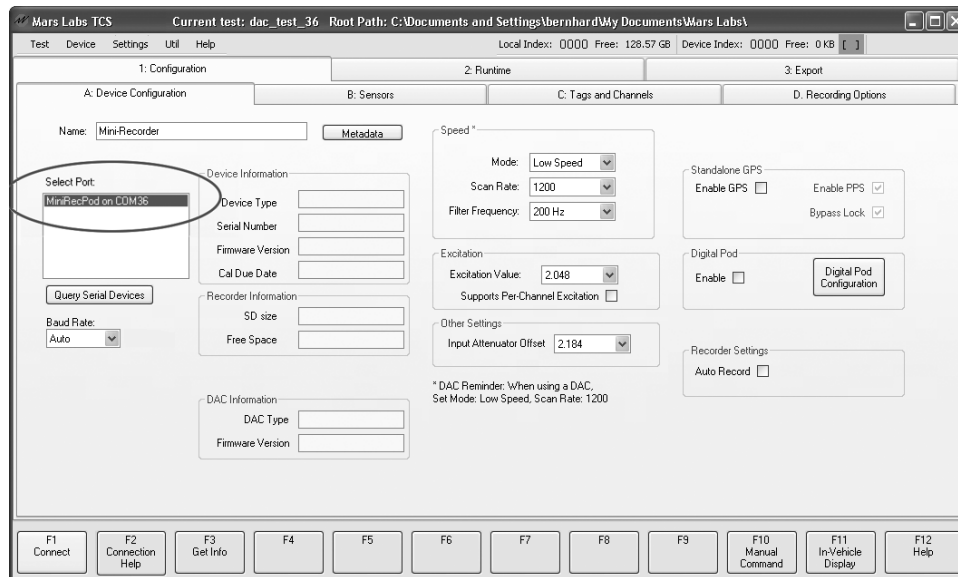

Once connected, the ‘Device Information’, ‘Recorder Information’ and ‘DAC Information’ areas will display information about the connected Titan hardware. For the DAC Test, the Mode, Scan Rate and Filter Frequency are optimally configured for the DAC:

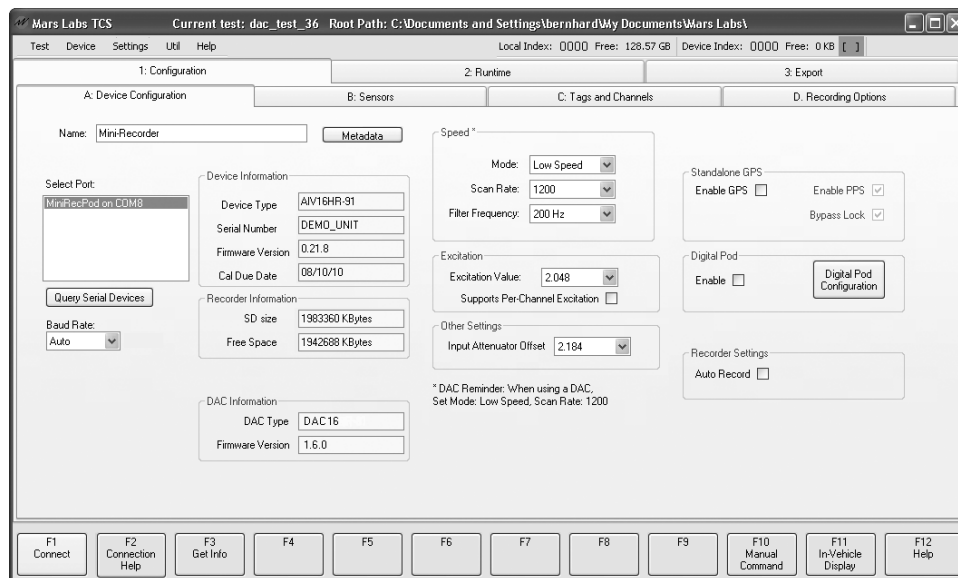

NOTE: The Titan DAC runs in Low Speed mode at a 1200 Hz scan rate.

Configuration: The Sensors Tab

Configure the Sensors by clicking on the ‘Sensors’ tab. The Sensors tab window is where you select and configure the types of sensors that will be connected to the Titan device (Accelerometers, Strain Gauges, etc).

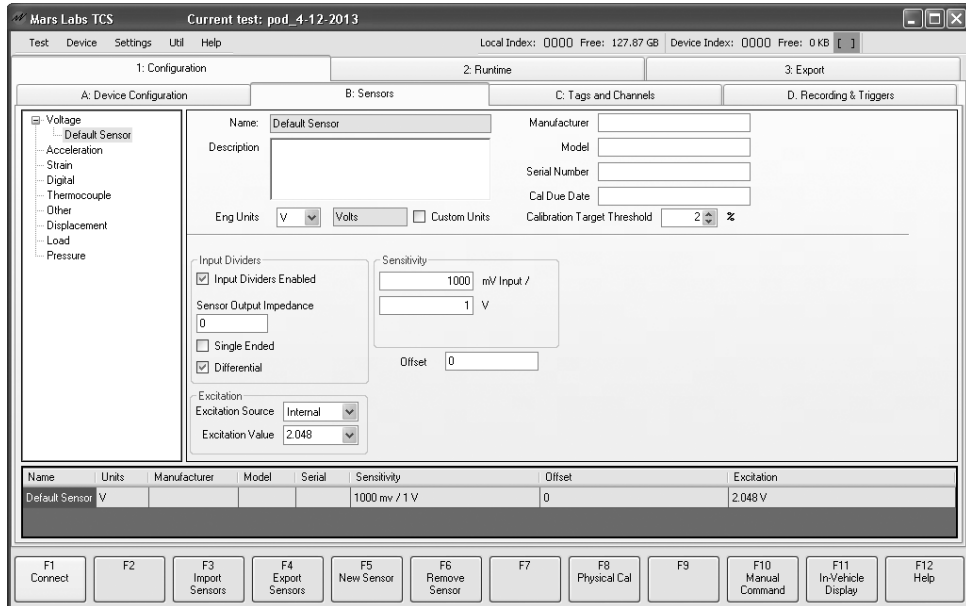

To add a sensor, click on the ‘New Sensor’ button [F5]. In the prompt that appears, type in the name of the sensor. Select the type of sensor from the ‘Type’ drop-down menu, and then click ‘OK’. Note that once you click ‘OK’ the sensor name cannot be changed.

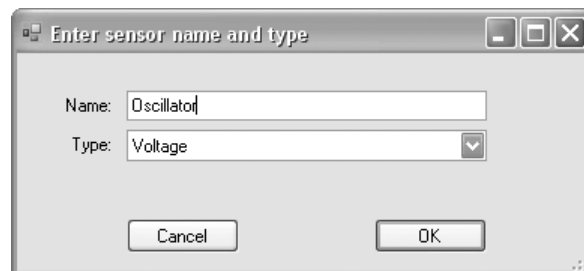

NOTE: You can also create a new sensor simply by double-clicking on the desired sensor type in the Sensor Tree. Any sensors created in this manner will be named automatically, however, you will not be able to specify a sensor name.

As sensors are added, each name will appear in the Sensor Tree on the left side of the window. You can enter additional information about each new sensor (description, manufacturer, model, etc.) in the editable fields. A table at the bottom of the window provides an overview of all added sensors.

NOTE: The Overview Table is for display only; it cannot be used for editing

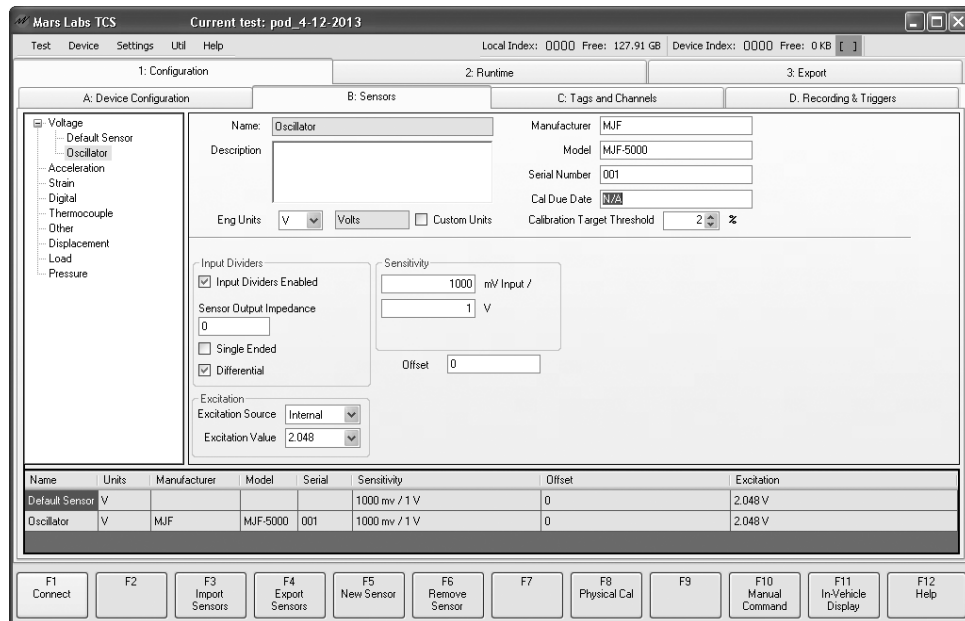

Continue adding sensors in this manner until all sensors have been defined.

Configuration: The Tags and Channels Tab

To configure the input channels of the Titan device, click on the ‘Tags and Channels’ tab. Note that in this window, all channels are initially assigned to a default voltage sensor type.

To assign a sensor to a channel, highlight the desired channel in the Channel Tree on the left and then select the sensor from the Sensor drop-down (shown) or by clicking on the ‘Browse’ button and selecting from a list. As each sensor is assigned to a channel, the assignment will appear in the table at the bottom of the window. The table provides a detailed overview of all channel assignments and is intended for display only; it is not available for editing.

The screenshot shows the Mars Labs TCS configuration window. The 'Tags and Channels' tab is active, showing a tree view of channels on the left and a configuration panel for 'Chan_01' in the center. The configuration panel includes fields for Name, Sensor, Gain, Bal Type, Warning, Range, Resolution, and Excitation. A table at the bottom displays the configuration for all channels.

Device	#	Name	SensorName	Gain	BalType	CalType	InputDividers	Range	Resolution	Excitation	Displayed
Mini-Recorder	1	Chan_01	Default Sensor	1	NO	VCAL	YES	± 32.767 V	0.001 V	2.048 V	True
Mini-Recorder	2	Chan_02	Default Sensor	1	NO	VCAL	YES	± 32.767 V	0.001 V	2.048 V	True
Mini-Recorder	3	Chan_03	Default Sensor	1	NO	VCAL	YES	± 32.767 V	0.001 V	2.048 V	True
Mini-Recorder	4	Chan_04	Default Sensor	1	NO	VCAL	YES	± 32.767 V	0.001 V	2.048 V	True
Mini-Recorder	5	Chan_05	Default Sensor	1	NO	VCAL	YES	± 32.767 V	0.001 V	2.048 V	True
Mini-Recorder	6	Chan_06	Default Sensor	1	NO	VCAL	YES	± 32.767 V	0.001 V	2.048 V	True

Continue assigning sensors to channels until sensors have been assigned for the channels of all connected devices, then select ‘SAVE’ in the TEST menu to save your test configuration. TCS is now configured for basic testing. Additional recording options (shown on the following page) can be specified if event triggering or routine start/stop recording is desired.

Configuration: The Recording & Triggers Tab

To enable and configure triggers, click on the ‘Recording & Triggers’ tab. The ‘Recording & Triggers’ window allows you to specify the parameters that will start and stop remote recording on the connected Titan device, enable file handling options for remote recording (see File Controls, page 102), select an alarm port and establish trigger conditions for local recording to TCS.

In the ‘Device Triggers’ pane, independent start trigger and stop trigger channels can be specified, along with independent trigger types and thresholds. The ‘Post Trigger Time’ field allows you to specify the amount recording time that will continue after a ‘Stop Trigger’ event is received.

NOTE: Device Triggers are only applied when Auto Record is enabled. For more on Auto Record, see page 46.

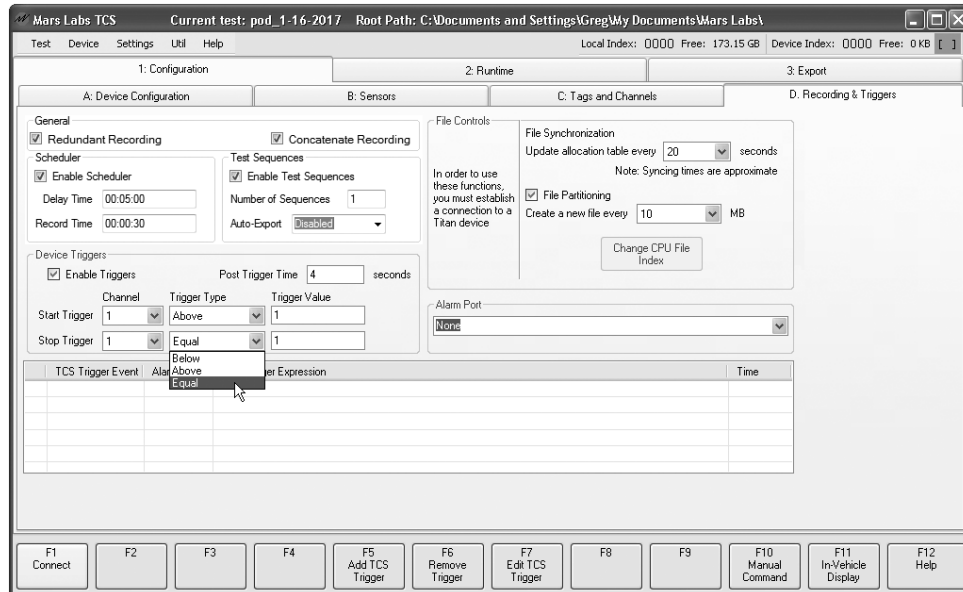

TCS Triggers are also created here. TCS Triggers are user-defined mathematical expressions that establish specific trigger conditions for start/stop recording and for alarms. TCS Triggers (page 104) are exclusive to TCS, and do not apply to remote recording.

The ‘Scheduling’ function allows recordings to be scheduled in short, non-continuous segments. Like TCS Triggers, this function is only available for recording locally to TCS; it is not implemented for recording remotely. When the Scheduling function is enabled, recordings will occur according to the ‘Delay Time’ and ‘Record Time’ parameters. ‘Delay Time’ sets the frequency of the recording, while ‘Record Time’ sets the duration.

The ‘Test Sequences’ pane permits multiple test sequences to be recorded under a given test.

The Recording & Triggers window also allows you to enable Redundant Recording, which automatically engages both recording modes (Local and Remote) when recording is initiated. Redundant Recording works with both Scheduling and Trigger Modes, but not with TCS Triggers. It is not supported with Titan DACs.

The Runtime Tab

To view and record incoming data, click on the ‘Runtime’ tab at the top of the screen. A Runtime plot window will appear:

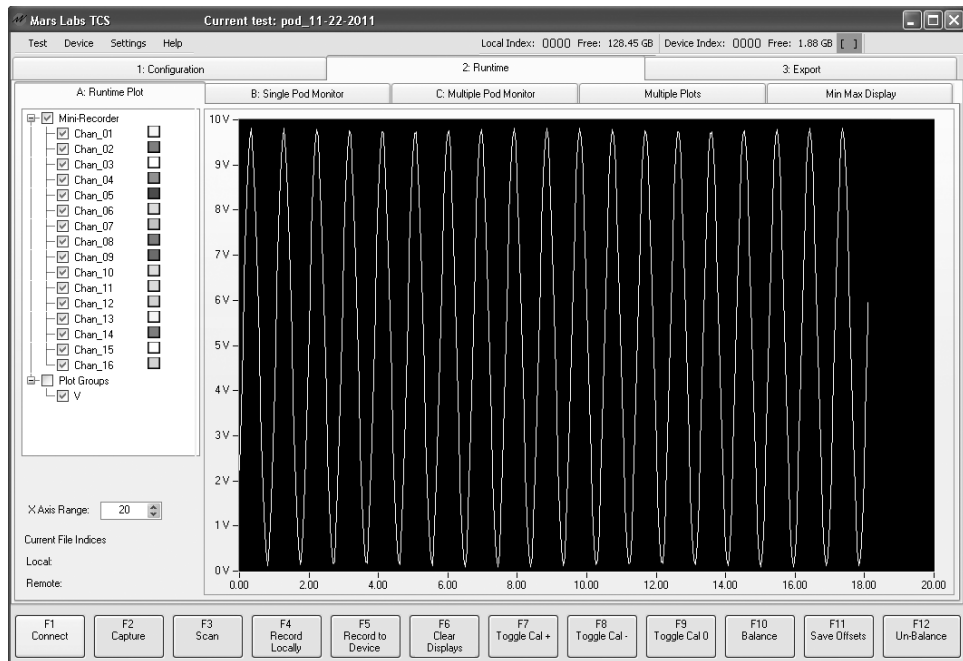

To begin monitoring incoming data, press the ‘Scan’ button [F3]. The Scan button will briefly glow yellow indicating that the TCS application is transmitting the sensor configuration to the connected Titan device. After a few seconds, the Scan button will glow green indicating that TCS is now monitoring the incoming data.

You can display any channel, any group of channels or all channels from all connected devices in the Runtime window by clicking on the related checkboxes in the Channel Tree display. The colors used for plotting can be changed by right-clicking on the channel(s) you wish to change. To quickly view all channels simultaneously, select the Device checkbox at the top of the channel tree. To refresh the plot at any time, click ‘Clear Displays’ [F6].

You can view the data in a numerical format by clicking on the ‘Single Pod Monitor’ tab at top of the screen. Both the plotted and numerical data can be viewed simultaneously by creating a separate display for the numerical monitor using the ‘Detach’ button located in the upper right corner.

NOTE: When you click on the ‘Detach’ button, it opens a separate Digital Monitors window, and the button label changes to ‘Reattach’. When you click on ‘Reattach’, the Digital Monitors window closes and the data in that window reappears under the ‘Single Pod Monitor’ tab.

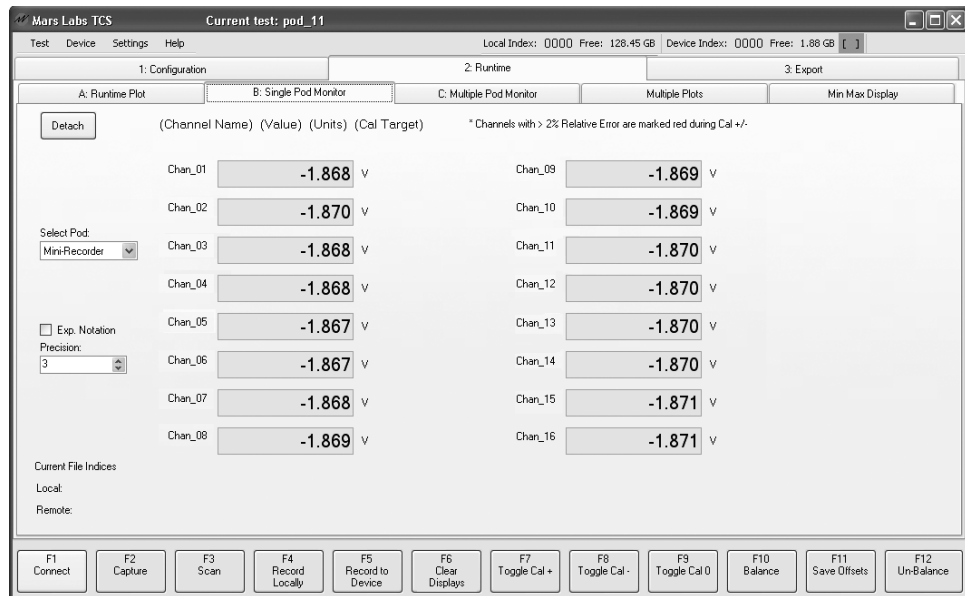

Incoming data can be recorded either locally to the PC hard drive, or remotely to the SD card in the Mini-Recorder, or to the built-in memory of the Titan CPU. To start recording, TCS must first be monitoring the incoming data ([F3] will be highlighted in green). Click on ‘Record Locally’ [F4] or ‘Record to Device’ [F5] to begin recording. While recording, the ‘Record’ button(s) will appear highlighted in red. Both local and remote recording can be run simultaneously. Pressing the ‘Record’ button a second time will stop recording, but continue monitoring. Clicking the ‘Scan’ [F3] button will stop both the recording and monitoring functions.

NOTE: Do not physically disconnect the Titan device while scanning or recording. Stop the scanning/recording operation and press ‘F1’ to disconnect the device from the TCS application prior to removing the USB connection.

Multiple Pod Monitor

If you are using a Titan CPU with multiple Titan devices, you can view the data for all devices by clicking on the ‘Multiple Pod Monitor’ tab at the top of the screen:

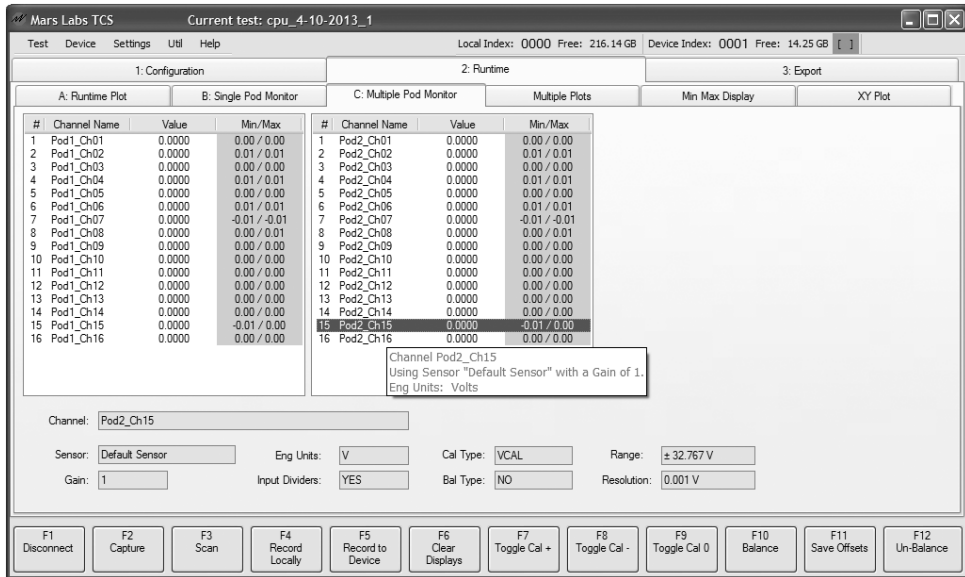

To view information about a specific channel in a given Titan device, simply select the channel of interest. The fields at the bottom of the window will display the configuration information of the selected channel.

Multiple Plots

To view plots of individual channels, select the ‘Multiple Plots’ tab and then select the desired channel(s) to display:

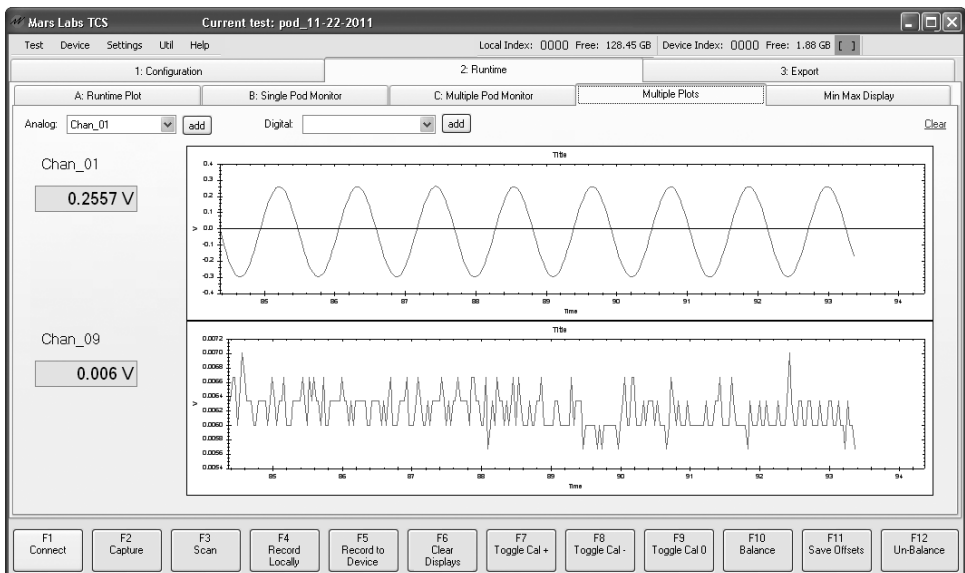

Min Max

To get an overview of the minimum and maximum channel values, select the 'Min Max' tab:

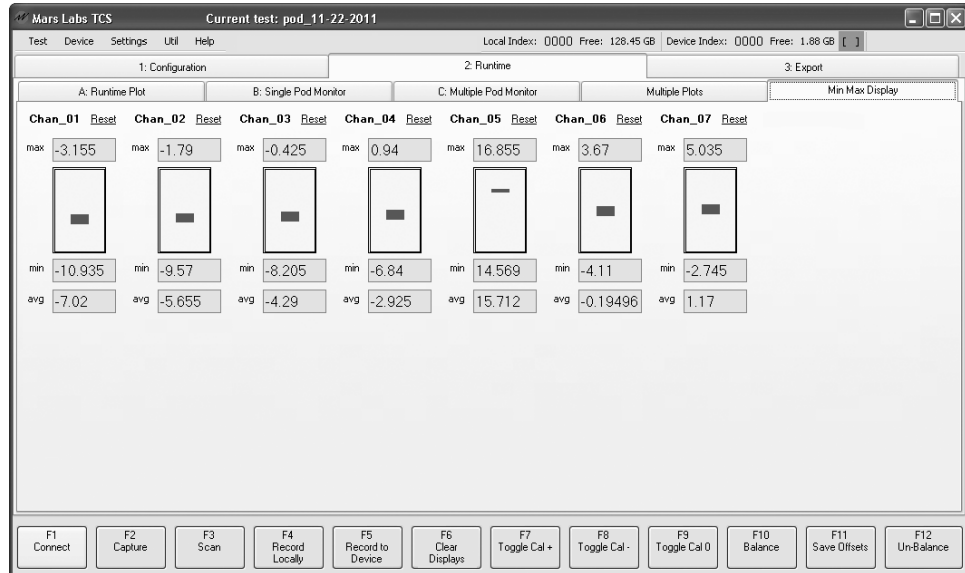

The minimum, maximum and average values from each enabled channel will be displayed. To reset individual channels, click on the associated 'Reset' channel label. To reset all values, click "Clear Displays" [F6].

NOTE: The MinMax display will only show the first 16 enabled channels. When using a CPU with multiple Pods connected, only the first 16 enabled channels will be displayed, starting with the Pod at Port 1, then Port 2, etc.

XY Plots

To view a display of two channels plotted against each other, select the 'XY Plots' tab:

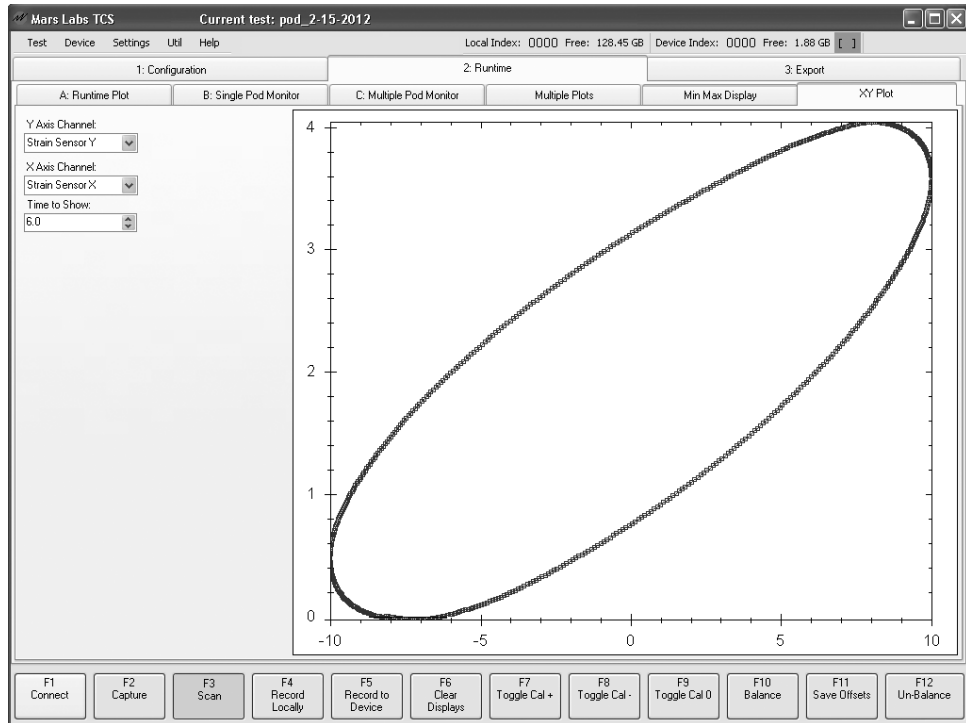

The XY Plot screen provides a continuously updated 'X versus Y' display of data points from any two channels. The two channels are selected using the 'X-Axis' and 'Y-Axis' dropdown menus. The 'Time to Show' parameter determines the number of data points that will be displayed based on the current Scan Rate. For example, if the Scan Rate is 100 Hz and the 'Time to Show' parameter is set for 6 seconds, then the X-Y Plot will be continuously updated with the most recent 600 data points.

NOTE: When using a CPU, the X-Axis and Y-Axis dropdowns include the port numbers of the connected Titan devices:

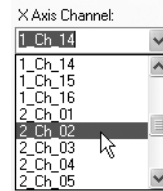

NOTE: XY Plotting is a CPU-intensive function. On general-purpose PC's, performance can become sluggish at high scan rates. For best performance when XY Plotting is desired, the recommended scan rate should not exceed 600 Hz.

GPS

If ‘Standalone GPS’ is enabled, a ‘GPS Display’ tab is added to the Runtime screen that allows you to view the parameters associated with the GPS sensor:

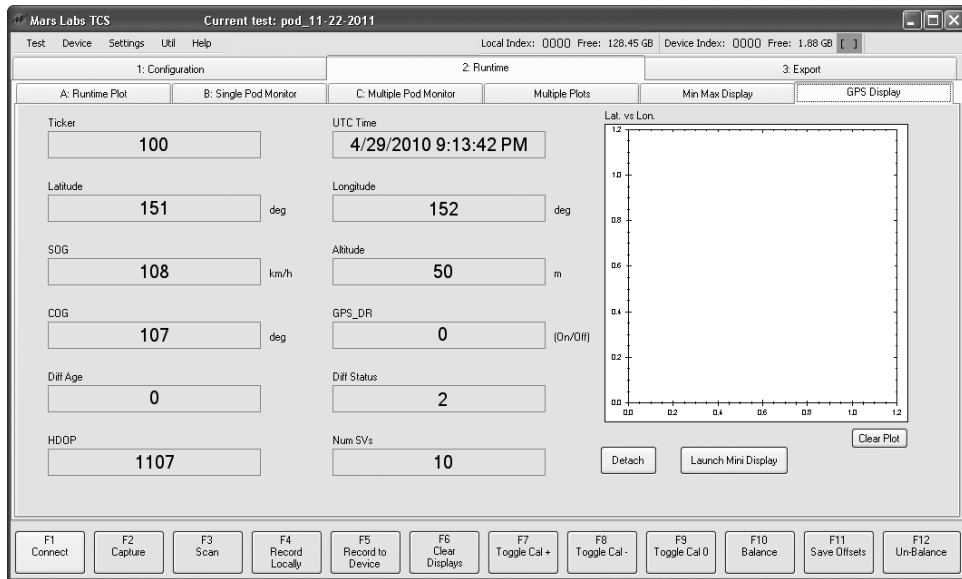

Digital Pod

If the Digital Pod is enabled and configured, a dedicated ‘Digital Pod Display’ tab is added to the Runtime screen. The display provides a real-time display of data values for each digital sensor:

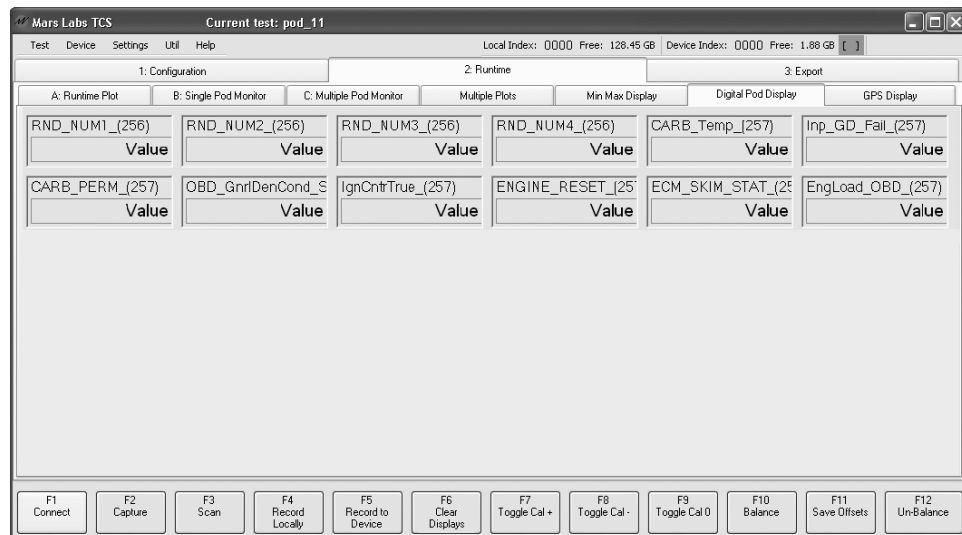

NOTE: The Digital Pod Display will support up to 250 channels; any channel past that number is not displayed. Recording of digital data is not affected by this limitation.

IMU Display

When the Digital Pod Serial Port is configured for the 3DM-GX3 Inertial Measurement Unit (IMU), an 'IMU Display' tab is added to the Runtime screen. The display provides a real-time plot of the sensor data along with a readout of the instantaneous values:

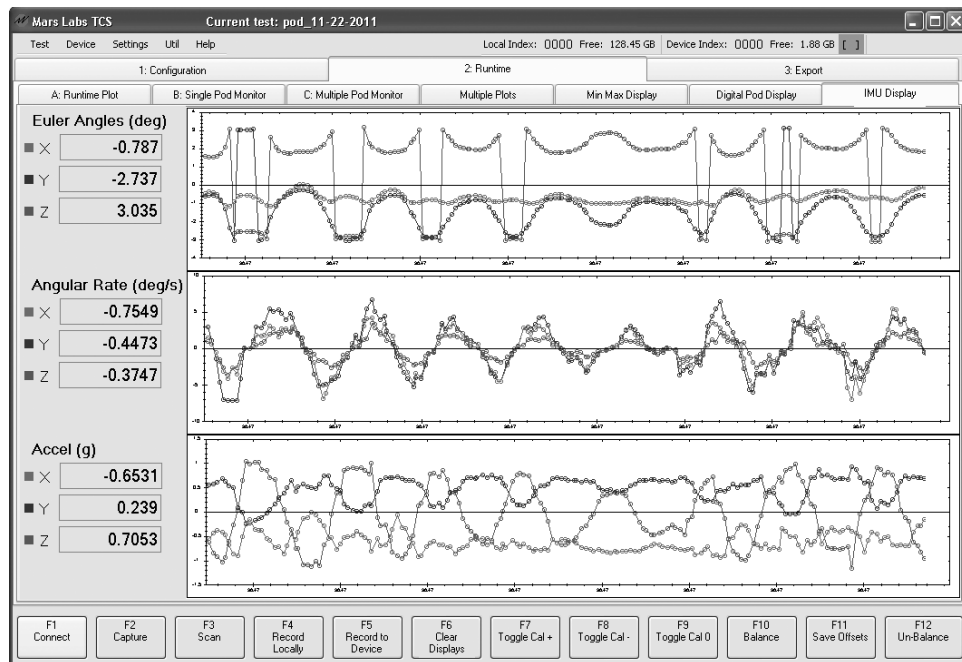

Wheel Force Transducer

When the Digital Pod is configured for a Wheel Force Transducer (WFT), two additional display tabs are added to the Runtime screen: 'WFT Monitor' and 'WFT Plot'. The WFT Monitor screen provides a realtime display of the data from each wheel sensor group:

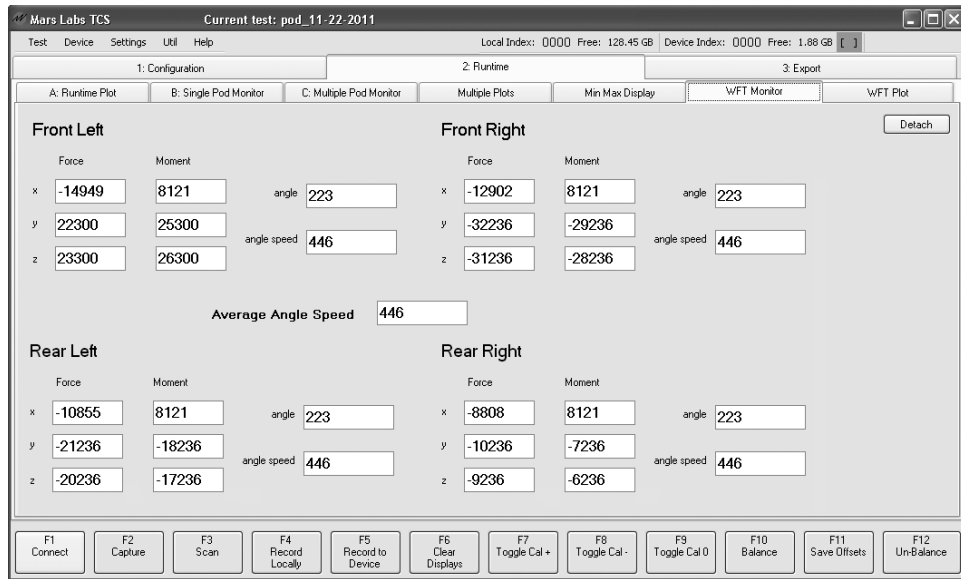

The WFT Plot screen provides a selectable realtime plot of the individual Force, Moment and Angle parameters from each wheel. Checkboxes in the left menu panel are used to select the desired parameters to plot:

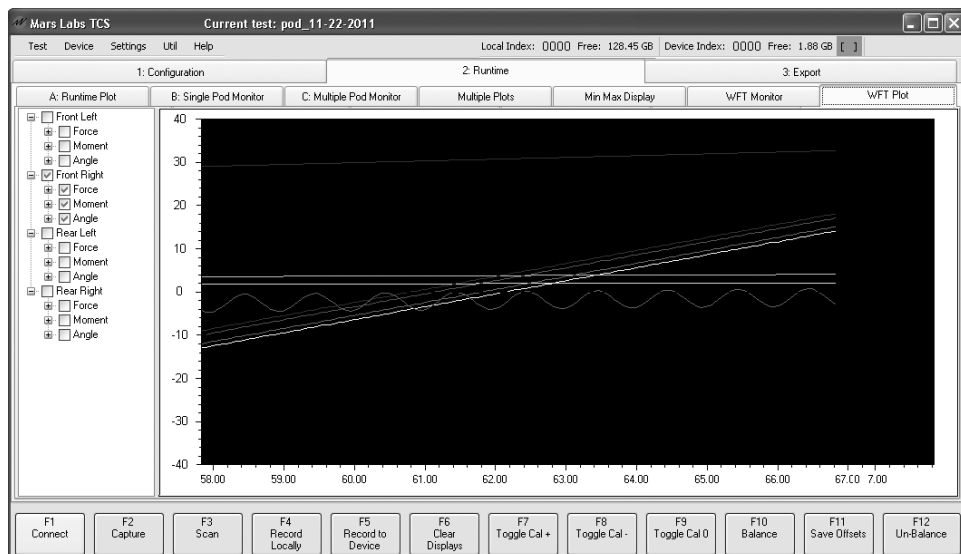

The Export Tab

To export recorded data sets, access the exporter function by clicking on the ‘Export’ tab.

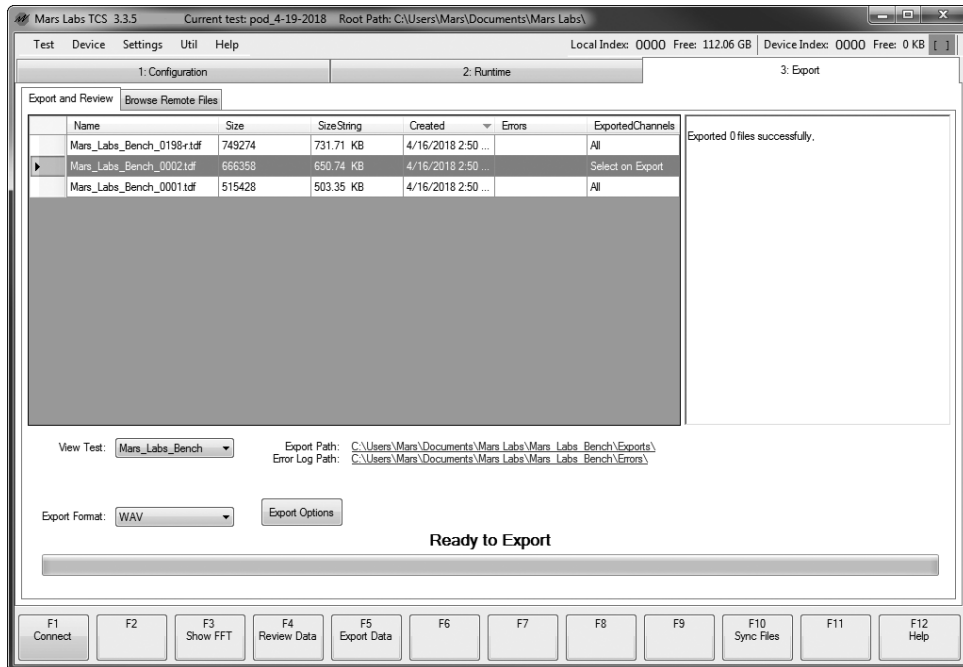

The Export window displays all of the locally recorded files that were created under the current test name. Functions in the ‘Export and Review’ tab allow you to review the data record [F3], view an FFT of a single channel [F5], export the data record [F5], export specific channels in the data record [F5 + selected Export Channels], and synchronize files based on common GPS/PPS packets [F10].

A separate tab within the Export window (labeled ‘Browse Remote Files’) allows you to view and transfer files from connected Titan devices or from alternate locations. To access remote files, click the ‘Browse Remote Files’ tab, and then click the **Browse Device** button to view files stored on the connected device, or click on the **Browse SD** button to access files stored in alternate locations.

To transfer remote files into TCS, select the desired file(s) and then click **Transfer Files**. To view the newly transferred files, switch back to the ‘Export and Review’ tab and select any of the standard viewing options. Note that you may have to change the test name that appears under the ‘View Test’ drop down in order to see any transferred files.

Files transferred from a connected device will have a '-r' or '-e' appended to the file name:

Sample_Test_0002-r.tdf
Sample_Test_0002-e.tdf

An '-e' in the file name indicates that the device's Error light was ON when the data was recorded; that data should be reviewed for errors.

Files imported from alternate storage locations will have an '-i' appended to the file name:

Imported_Test_003-i.tdf

FFT Review Window

To view an FFT of a single channel from a data set, select the desired data set and then click on the 'Show FFT' button [F3]. This action brings up an FFT Review window that provides a thumbnail display of the complete test record at the top, and a plot and FFT of the data beneath. The window defaults to displaying data from Channel 1 with a window size equal to the scan rate. To view a different channel, make a selection from the Channel drop-down. To adjust the FFT window size, enter the desired value in the Window Size field. The Window Size can be adjusted from 4 to 32767 points. After making the selections, click the 'Reload' button to update and view the plot.

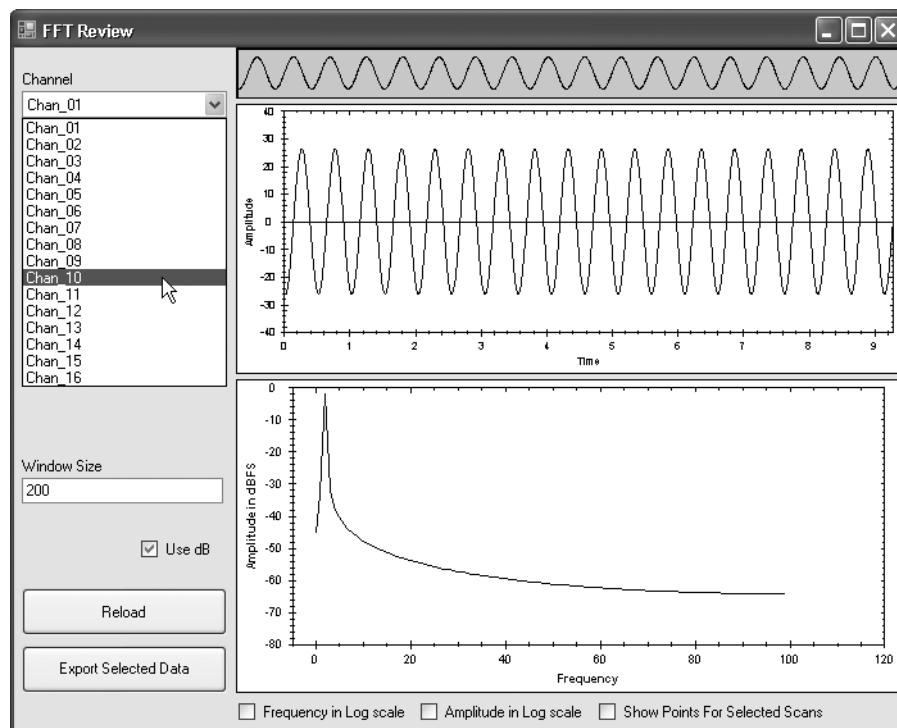

The 'Use dB' checkbox is enabled by default, displaying the signal amplitude in dB Full Scale. Using the checkboxes at the bottom of the window, you have the option of changing the both the Amplitude and Frequency display scaling to logarithmic, as well as showing the sample points of the data. These display options take effect immediately without having to select 'Reload'.

NOTES: Additional instances of the FFT function can be created by repeatedly pressing [F3]

To zoom in to review finer details, select a subsection of the data by dragging across a portion of the thumbnail data record (at the top) or anywhere in the main plot window:

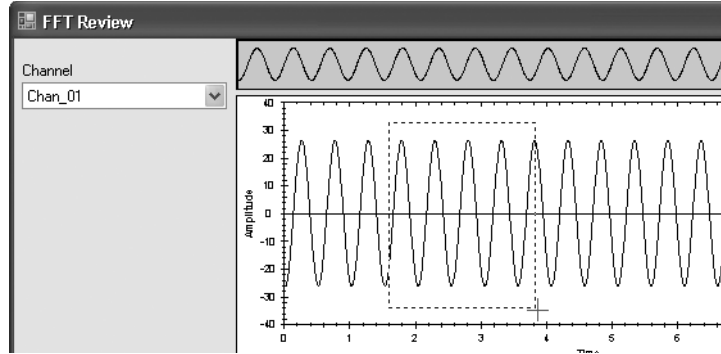

All panes within the FFT Reviewer window are automatically updated to reflect the selected data subsection, including the FFT plot:

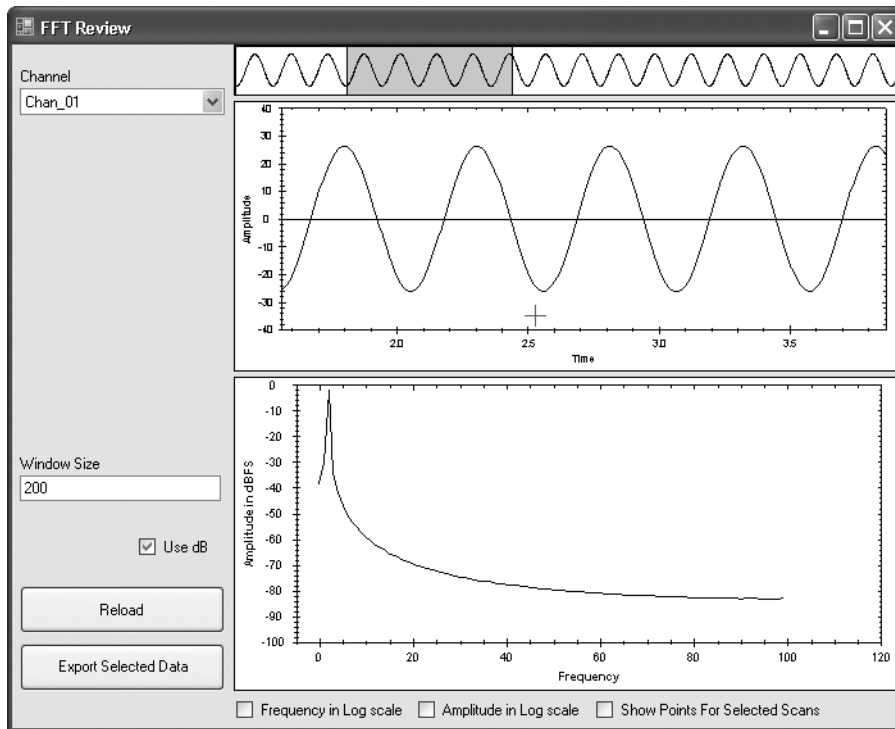

NOTES:

1. In magnified views as described above, if the window size is greater than the number of points in the selected data portion, FFT accuracy will be reduced.
2. The mouse scroll wheel can also be used to zoom in or zoom out of the plot.

Exporting Selected FFT Data

Selected subsections in the FFT Reviewer window can be exported as separate files by clicking on the 'Export Selected Data' button. This action will create a new .tdf file in the Export and Review window with a two-digit dash number appended to the file name as shown below.

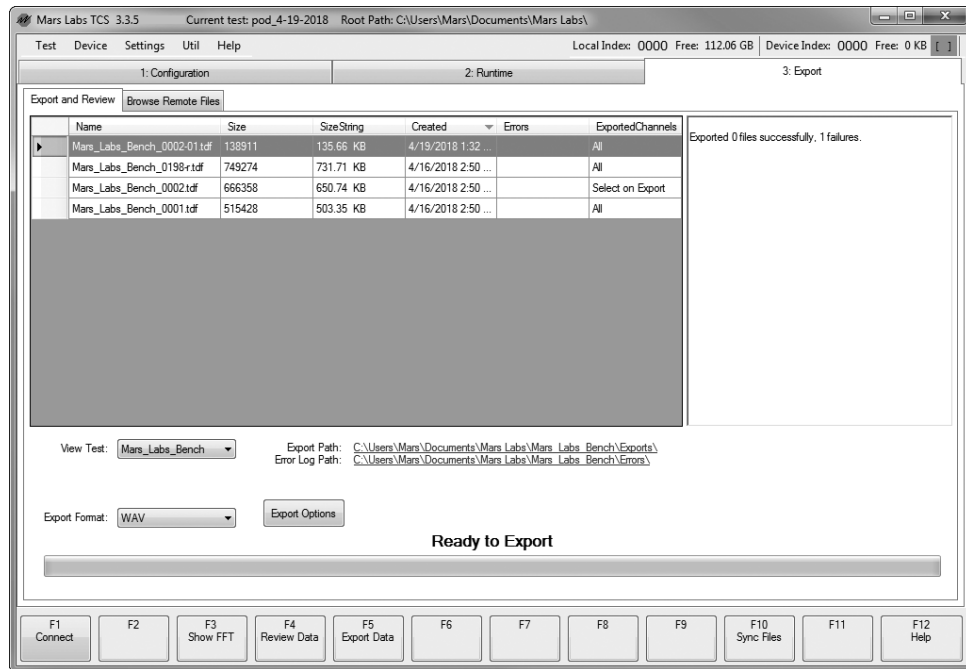

Additional Operations in the FFT Reviewer

In the FFT Review window, holding down the CTRL key while dragging the mouse allows you to pan the data left or right, up or down. To access additional image manipulation options, right-click anywhere inside the window to bring up a contextual menu of selections:

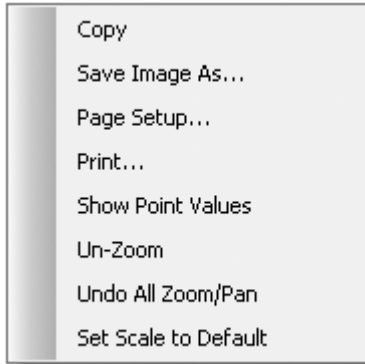

Copy - Copies the current FFT plot to the clipboard

Save Image As... - Allows you to save the current FFT plot in one of six different formats:

- .emf (Windows Extended Metafile Format)
- .png (Portable Network Graphics)
- .gif (Graphical Interchange Format)
- .jpg (Joint Photographic Experts Group)
- .tif (Tagged Image File Format)
- .bmp (Bitmap)

Page Setup - Produces the standard 'Page Setup' window

Print - Produces the standard 'Print' window

Show Point Values - Displays the closest X and Y data coordinates associated with the placement of the cursor in the FFT plot.

Un-zoom / Unpan - Allows you to undo the last zoom or pan operation. Repeatedly selecting this will step back through all zoom or pan operations until the original display is restored.

Undo All Zoom/Pan - Restores the display to the original state, undoing all zoom and pan operations.

Set Scale to Default - Restores the X and Y axis to the original default values.

When finished reviewing the FFT plot, click on the CLOSE box to dismiss the window and return to the Export window.

Reviewing Data

Any test file can be reviewed prior to export using the 'Review Data' button [F4] or by double-clicking on the data file. This action brings up a Multi-Plot window that provides a thumbnail display of the complete test record at the top of the window and an adaptive area below to display plots of selected data unit groups. Both analog and digital data types are supported (for more information, see 'Multi-Plot Review', pg 124).

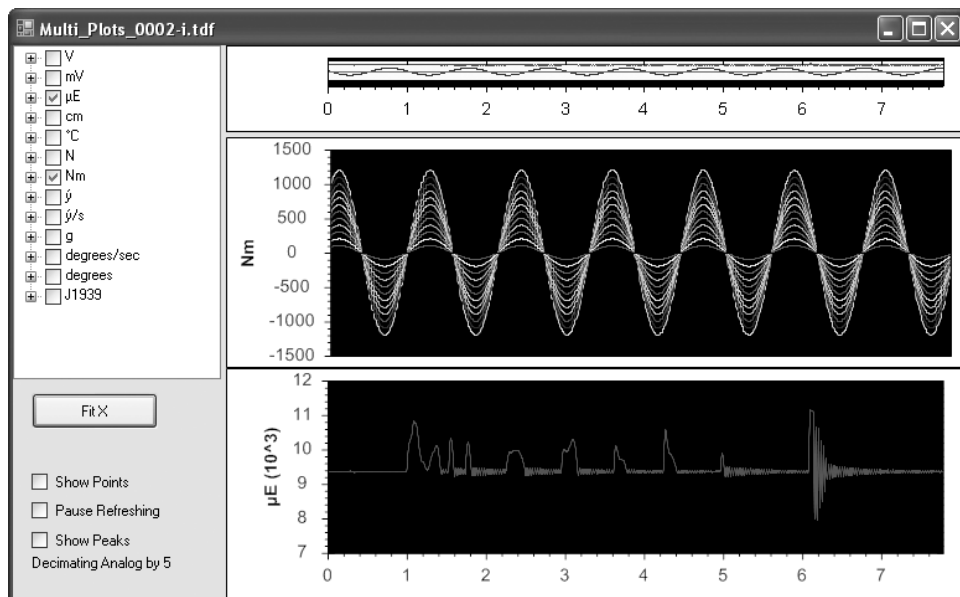

When finished reviewing the data, click on the CLOSE box to dismiss the window and return to the Export window.

NOTE: Multiple review windows can be open at the same time, permitting comparisons with other runs from the current test series.

Exporting - Export Format

Test data can be exported in seven file formats:

WAV - PC sound file format. Permits data viewing using standard PC sound applications.

WAVIEEEE - PC sound file format of transform-scaled data. Permits data viewing using standard PC sound applications.

CSV - ‘Comma Separated Value’, a plain text data file with fields separated by commas.

TSV - ‘Tab Separated Value’, a plain text data file with fields separated by tabs.

RPCIII - Standard data format used in noise and vibration measurement/analysis systems.

MATLAB - Data format compatible with MATLAB

HDF5 - Portable data format for managing very large data collections

HDF5HP - A high performance version of the HDF5 format

BLOb - ‘Binary Large Object’, DBMS files in a binary format

Use the ‘Export Format’ drop-down to select the desired file format:

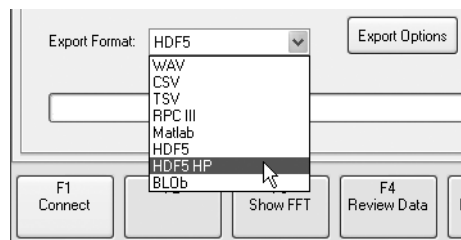

Several of the file formats offer additional exporting options that are accessed by selecting the ‘Export Options’ button, as shown below.

NOTES:

1. *HDF5HP (‘HDF5 High Precision’) exports as a 64-bit floating point number (64-bit with at least 15 digits of precision), preserving the full precision of exported GPS data.*
2. *HDF5 exports as a 32-bit floating point number (32-bit with 7 digits of precision). This results in a loss of precision of exported GPS data. Other exporters (MatLab and CSV), preserve the full precision and can be used to review GPS data using standard external tools.*

Supported Data Types

Although TCS supports a wide range of analog and digital sensors, not every export file format supports every type of test data. The table below shows the export file formats and the supported data types.

Data Type	Export File Format					
	WAV	CSV / TSV	RPC III	MatLab	HDF5	BLOB
Analog Data	X	X	X	X	X	X
J1939 CAN	X	X	X	X	X	X
ISO CAN		X		X	X	X
WFT	X	X	X	X	X	X
IMU	X	X	X	X	X	X
GPS		X *		X	X	X
Metadata & Device Info					X	
Pseudo Channels		X			X	

* Can be exported as a separate file

NOTE: RPC III and WAV will both store GPS and ISO CAN data, but the way that they are stored is frequency dependent, and these data types are asynchronous.

Export Options

In the Export screen, clicking on the 'Export Options' button produces a window where you can select the various options available for each export format:

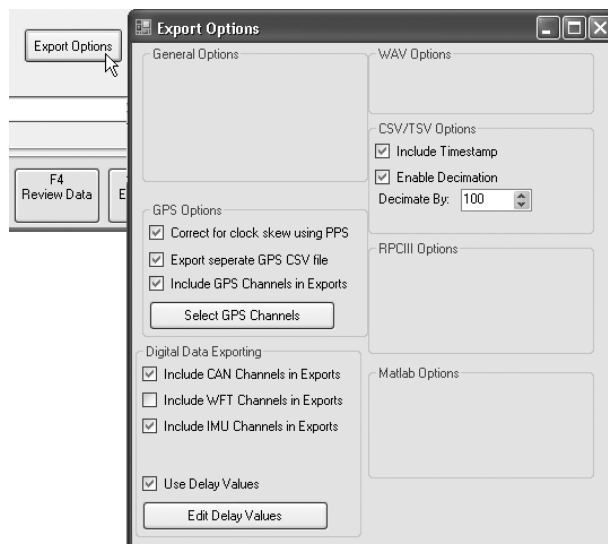

Export Options

CSV / TSV Options:

Include Timestamp - When checked, the Timestamp will be included with the exported CSV or TSV data. An example is shown below.

	A	B	C	D	E	F	G	H	I	J	K
1	Time	Chan_01	Chan_02	Chan_03	Chan_04	Chan_05	Chan_06	Chan_07	Chan_08	Chan_09	Chan_10
2	Seconds	V	V	V	V	V	V	V	V	V	V
3	0	1.707625	1.487	0.427	1.056	0.839	0.632	0.412	0.212	-0.002	0.0
4	0.000244	1.708313	1.488	0.427	1.055	0.84	0.632	0.412	0.211	-0.002	0.0
5	0.000488	1.7085	1.487	0.427	1.056	0.838	0.632	0.412	0.21	-0.003	0.0
6	0.000732	1.709688	1.488	0.428	1.058	0.841	0.633	0.412	0.211	-0.001	0.0
7	0.000977	1.711375	1.49	0.429	1.058	0.841	0.634	0.413	0.212	-0.002	0.0
8	0.001221	1.712625	1.49	0.428	1.058	0.84	0.633	0.412	0.211	-0.003	0.0
9	0.001465	1.713813	1.492	0.428	1.059	0.841	0.634	0.412	0.212	-0.002	0.0
10	0.001709	1.715563	1.494	0.429	1.061	0.842	0.635	0.413	0.213	-0.002	0.0

*Exported 'CSV' data file with timestamp
(viewed in Microsoft Excel)*

An example of an exported 'CSV' file might look like this:

Sample_test_0002.csv

where:

'Sample_test' is the test name

'0002' indicates the second recorded dataset (indices)

' .csv' is the file format

Enable Decimation - When this is checked, exported data will be decimated by the value in the 'Decimate By' field.

Decimation values are in the range of 1 - 1000. Entries can be made by using the increment/decrement button, or by manually entering a value in this field.

GPS Options:

Correct for clock skew using PPS – When checked, analog scans will be adjusted using the PPS signal from the GPS unit. The exporter will report the clock skew adjusted in ppm after exporting.

Export separate GPS CSV file – When checked, GPS data will be exported to a separate CSV file with a column for each GPS field. It will also include a column that maps the analog scan time of each packet.

Include GPS channels in Exports – When checked, the GPS data will be included with the analog export, padded to the analog rate.

Select GPS Channels – Produces a window to select specific GPS fields to include with analog data exports:

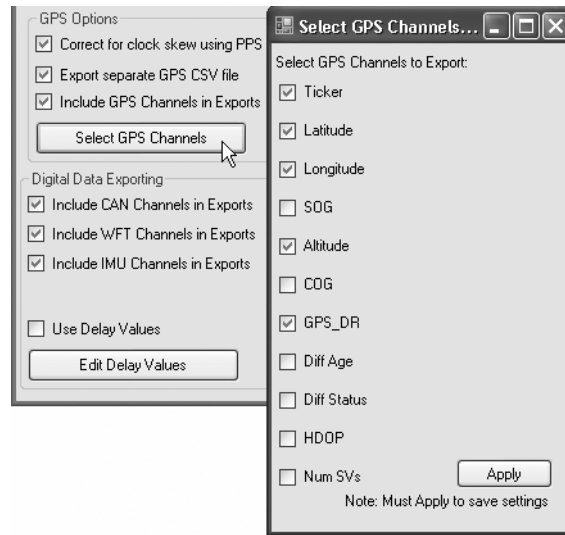

When ‘Export separate GPS CSV file’ is selected, the exported data file will have the same name and indices as the test file, but include ‘gps’ in the filename:

Sample_test_0002-gps.csv

An example of an exported GPS file:

	A	B	C	D	E	F	G	H	I	J
1	Scan Count	UTC Time	Latitude	Longitude	Altitude	COG	SOG	DR	Num SVs	HDOP
2	342	2010:04:30:18:16:50.8	39.1058133	-76.845717	0	11519	16	0	3	260
3	738	2010:04:30:18:16:51.0	39.1058133	-76.845717	0	11519	11	0	3	260
4	1134	2010:04:30:18:16:51.2	39.1058133	-76.845717	0	11519	3	0	3	260
5	1536	2010:04:30:18:16:51.4	39.1058133	-76.845717	0	11519	11	0	3	260
6	1938	2010:04:30:18:16:51.6	39.1058133	-76.845717	0	11519	0	0	3	260
7	2334	2010:04:30:18:16:51.8	39.1058133	-76.845717	0	11519	7	0	3	260
8	2736	2010:04:30:18:16:52.0	39.1058133	-76.845717	0	11519	11	0	3	260
9	3132	2010:04:30:18:16:52.2	39.1058133	-76.845717	0	11519	7	0	3	260
10	3534	2010:04:30:18:16:52.4	39.1058133	-76.845717	0	11519	16	0	3	260

*Exported GPS data file
(viewed in Microsoft Excel)*

Digital Data Exporting Options:

‘Include’ checkboxes – When checked, the selected digital channels will be included with the analog export, padded to the analog rate.

Use Delay Values – When checked, delay values will be applied to the digital data during export. This function is used to compensate for any fixed delays in the digital stream, ensuring synchronization between the analog and digital data.

Edit Delay Values - Produces a window for entering delay values for each digital source:

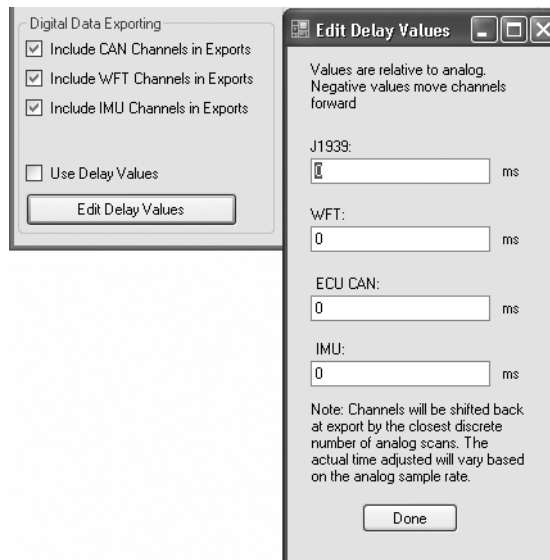

NOTE: When delay values are applied, the corresponding digital data will be shifted back by this amount during export.

For more information on delay values, refer to Applications Note
APN-1017 - Determining Signal Delay Between Analog Channels and WFT

Exporting the Data Record

After all format options are chosen, clicking the Export Data button [F5] will export the data from the currently selected data file in the selected export format. Exported data is stored in the Export folder under the current test name. To access the folder, click on the Export Path link.

Exporting Individual Channels

TCS also allows you to select individual channels for export; this option is available when the 'Select on Export' option is enabled in the Export Channels column (click to toggle between 'All' and 'Select on Export').

Errors	ExportedChannels	Expo
.	All	
.	Select on Export	
.	All	

When 'Select on Export' is chosen, an Export Channels Selector window will appear after you click on the Export Data button [F5]:

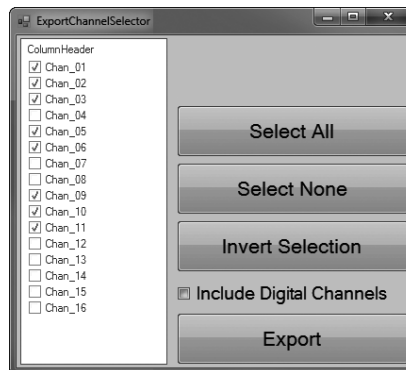

In this window, individual channels are selected by clicking on the desired channel checkboxes in the Column Header area. Buttons on the right allow you to alter selections, and allow you to include or exclude data from digital channels. After making channel selections in this window, clicking on the Export button completes the exporting function in the selected export format.

To exit from this window without exporting channels, click on the Close box.

Export File Path

The default Export path is ‘My Documents\MarsLabs\<test_name>’.

NOTE: To change the export path, select the ‘TCS Settings’ option in the *SETTINGS* menu and enter the new path.

After the data has exported successfully, a status message will appear in the upper right of the window. Sample message:

“Exported 1 files successfully, 0 errors”

If the transfer is successful but some data was lost in the process, the number of missing bytes will be displayed along with the computed percentage lost in transfer:

```
Transferred 3853253 of 3853288 bytes (35 bytes missing,
which is 0.00091%)
pod_5-29-2013_0002.TDF transferred. Saved to pod_5-
29-2013\pod_5-29-2013_0002-r.tdf
```

```
Transferred 1 files successfully, 0 failures.
```

If an error occurs during the transfer and the export is not successful, a status message indicating the error will be displayed:

```
Problem with pod_5-29-2013_0002.TDF: Transfer timed
out (40 bytes left). Retry, or try reading the test file from
the SD card using an SD card reader and a PC.
Transferred 0 files successfully, 1 failures.
```

If you receive this message, you have the option of retrying the transfer or using a card reader to transfer the data directly from the SD card. Note that the card reader method is preferable when large data files (>400Mb) are being transferred, as this method is faster and less prone to errors.

Advanced Settings

A description of the TCS windows and features appears below.

Configuration Tab

The 'Configuration' tab provides a series of related screens to configure the connected Titan Device(s), configure Sensors, and select Tag and Channel assignments for the TCS application. Individually tabbed windows are provided for each of these functions:

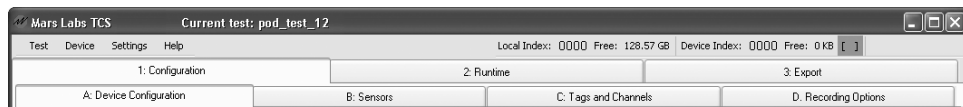

Device Configuration - Mini-Recorder

The Mini-Recorder *Device Configuration* screen allows you to connect to and configure the function of the connected Titan Mini-Recorder/Pod by selecting the device speed, scan rate and filter frequency. This window displays specific information about the connected device (device type, description, firmware version), and information about the SD memory card (if using a Mini-Recorder). It allows you to enable GPS, Digital Pod and Auto-Record functions, and enter Metadata information. The example below shows a Mini-Recorder configuration.

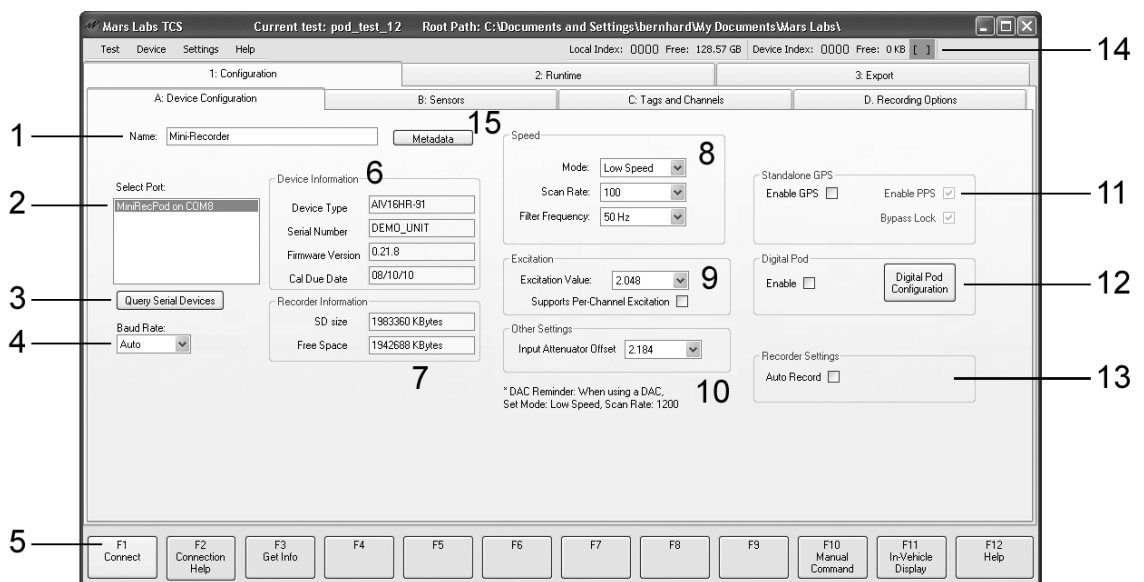

The components of the Device Configuration screen:

1. Name field – Allows you to specify a unique name for the device. This name is displayed in the channel list in the ‘Tags and Channels’ window.
2. ‘Select Port’ list – This list displays all connected Titan modules.
3. ‘Query Serial Device’ button – Use this button to check for connected hardware
4. Baud Rate dropdown - Selects the baud rate that TCS will use to connect to the Titan hardware. An ‘Auto’ setting means that TCS determines the baud rate based on the rate that is sent by Titan Device. Any other setting will force TCS to communicate at the selected rate.

NOTE: *If the baud rate is too low to support the scan rate, the connected Titan device will not output data over the serial port.*

5. Function keys – In the Device Configuration window, the Function keys are assigned the following functions:

- [F1] - Connects/disconnects to the device on the selected port
- [F2] - Displays the ‘Connectivity’ section of the TCS User Manual
- [F3] - Refreshes the Device Information display
- [F10] - For issuing Manual Commands to the connected device
- [F11] - Invokes the In-Vehicle Display
- [F12] - Invokes the embedded TCS User Manual

6. ‘Device Information’ – Displays information of the connected device, including the Device Type*, unit description, firmware version, and the Mini-Recorder SD memory card (capacity and free space).

* In the Device Type field, product codes appear as follows:

The first three letters indicate the general device type

The following number indicates the number of channels

The following letter indicates High or Low Speed capability

The letter ‘R’ indicates recording capability

The letters ‘A’ or ‘D’ indicates that the device has an internal expansion card installed:

‘A’ = Internal DAC

‘D’ = Internal Digital Pod

The letter ‘G’ indicates GPS support

Numbers that appear after the dash are codes that specify the connector type and the operating voltage.

Device Configuration screen components (cont.):

7. 'Recorder Information' – Displays capacity and free space information on the Titan device's SD memory card.
8. 'Speed' – The drop-down menus in this pane allow you to configure the device speed, scan rate, and filter frequency of the connected hardware:

Mode - Selects Very High Speed, High Speed, or Low Speed operation.

Scan Rate - Sets the scan rate. The available scan rates are:

Very High Speed: 11,025 - 60,000 samples per second per channel

High Speed: 128 - 10,000 samples per second per channel

Low Speed: 10 - 1200 samples per second per channel

NOTE: *Very High Speed (VHS) rates only apply to Titan II, Titan CAI, and Titan CPU08V devices. For more information, refer to Appendix B Scan Rates and Supported Configurations*

Filter Frequency - Sets the frequency of the anti-aliasing filter. The filter is automatically set to 0.49 of the scan rate when High Speed or Very High Speed mode is selected. For Low Speed operation, the available filter frequencies are: Bypassed, 5, 10, 20, 40, 50, 80, 100, 200, 230, 250Hz

9. 'Excitation' – Allows you to enable Per-Channel Excitation if the connected device supports this feature.

10. 'Other Settings' –

Input Attenuator Offset: Allows you select the offset voltage (2.048V or 2.184V) when the input dividers are enabled.

11. 'Standalone GPS' – Allows you to enable the GPS function if the connected device supports GPS. If the connected device does not support GPS, checking the 'GPS Enable' checkbox does nothing.

When GPS is enabled, checking the 'Bypass Lock' box allows the GPS to operate without locking to GPS satellites. This permits you to check the basic operation of the GPS function in areas where satellite reception is not available.

Checking the 'Enable PPS' box enables the Pulse Per Second function.

NOTE: *If the GPS sensor loses satellite lock during recording, the accuracy of synchronization functions that rely on Pulse Per Second (PPS) data may be affected and cannot be guaranteed. The typical drift when lock is lost is approximately 5 msec/hour. If GPS satellite lock is lost during recording, you should review the file if you are using PPS.*

Device Configuration screen components (cont.):

12. ‘Digital Pod’ – Allows you to enable and configure the Digital Pod function. For details on configuring the Digital Pod, see page 80.

13. ‘Recorder Settings’ – Allows you to select **Auto-Record Mode**. In Auto Record Mode, the Titan Mini-Recorder automatically begins remote recording upon power-up.

To enable Auto-Recording, click on the checkbox. The Auto Recording function will be enabled when you configure and run a new test. Once Auto-Recording is enabled, it will remain enabled until a new test is configured and run without Auto-Recording.

NOTE: *If Auto Recording is enabled but an SD memory card is not installed when the Mini-Recorder is powered on, recording will not initiate. Auto Recording remains enabled, however; the Mini-Recorder will record when power is applied with an SD memory card present.*

14. Alarm Indicator - The Alarm Indicator illuminates when an input signal exceeds the alarm threshold set in TCS Triggers and when the Alarm Indicator is set to ‘Toolbar’.

15. ‘Metadata’ button – Presents a window that allows you to enter specific Metadata information for the current test. Metadata fields are pre-defined for the following categories:

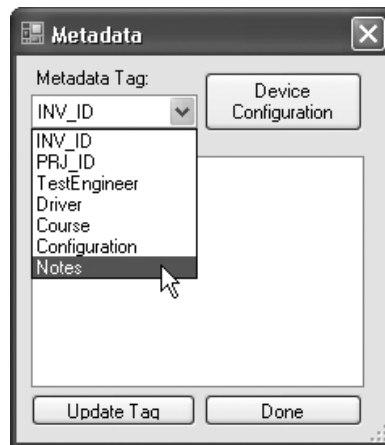

- INV_ID (Inventory identifier)
- PRJ_ID (Project identifier)
- Test Engineer (name of the engineer or technician conducting the test)
- Driver (the name of the driver)
- Course (the name of the test course)
- Configuration (the test configuration)
- Notes (miscellaneous information)

Each Metadata field will accommodate up to 128 characters of plain text except for the Notes field, which will accommodate an unlimited amount of plain text.

After making each entry, click on the ‘Update Tags’ button to add that information to the current test. Metadata entries are stored in both the .tcf and .tdf files. When finished with the entries, click on the ‘Done’ button (or simply close the window).

Metadata (cont.):

Metadata information for the current test can be reviewed and edited at any time by clicking on the 'Metadata' button. Note, however, that any edits to the metadata will only be applied to new test files and not to previously recorded files. You cannot edit the metadata associated with a test file *after* it has been recorded.

Metadata - Device Configuration

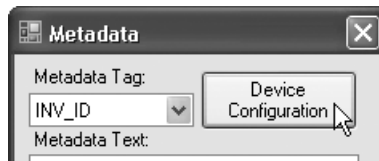

The Metadata window also includes a 'Device Configuration' button that allows you to view the device information that is received by TCS when the device is first connected (Function key [F1]). This information includes the firmware version, board revisions, serial numbers, and calibration dates:

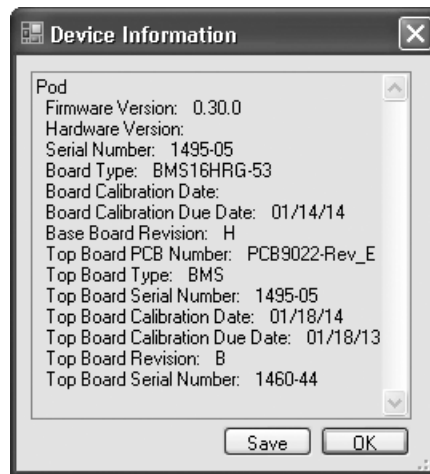

NOTE: If you are not connected to the Titan hardware before selecting the Device Configuration button, a warning screen will appear alerting you that the information presented in the 'Device Information' window may be taken from a previous test using a different device. If no previous test exists, the 'Device Information' window will be blank.

To save the Device Information with the test, click 'Save'. The information will be saved as separate configuration file (.cfg) in the current test folder and a 'Success' message window will appear:

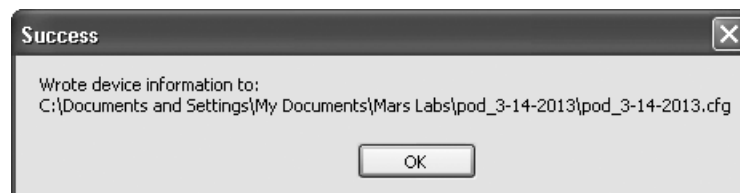

Metadata (cont.):

The Device Information .cfg file is a plain text file that can be viewed in a text editor, such as Windows Notepad:

```
Pod
Firmware Version: 0.30.0
Hardware Version:
Serial Number: 1495-05
Board Type: BMS16HRG-53
Board Calibration Date:
Board Calibration Due Date: 01/14/14
Base Board Revision: H
Top Board PCB Number: PCB9022-Rev_E
Top Board Type: BMS
Top Board Serial Number: 1495-05
Top Board Calibration Date: 01/18/14
Top Board Calibration Due Date: 01/18/13
Top Board Revision: B
Top Board Serial Number: 1460-44
```

The information presented in the Device Information window will appear differently for a CPU or DAC configuration. The CPU or DAC device information will be presented first, and then the Pod information will be displayed. For the CPU, Pod information will appear according to the connected port order as shown below.

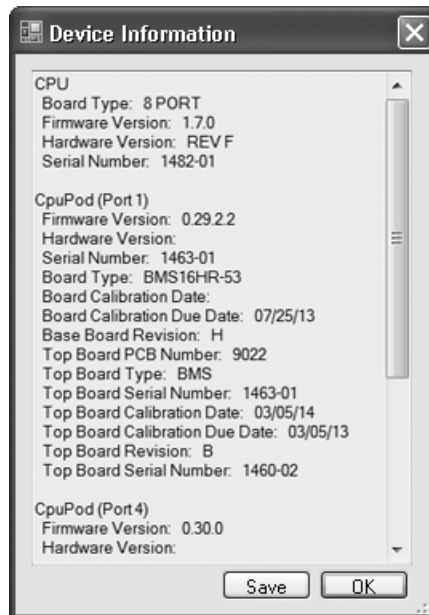

NOTE: If a DAC is part of a CPU system, the DAC information will appear in the CPU list along with Pod the DAC is attached to.

Device Configuration - Titan CPU

The Titan CPU *Device Configuration* screen allows you to connect to and configure the function of the Titan CPU Channel Expander. This window also displays specific information about Expander devices (device type, serial number, and firmware version), and information about all connected Titan Pod/Mini-Recorder hardware.

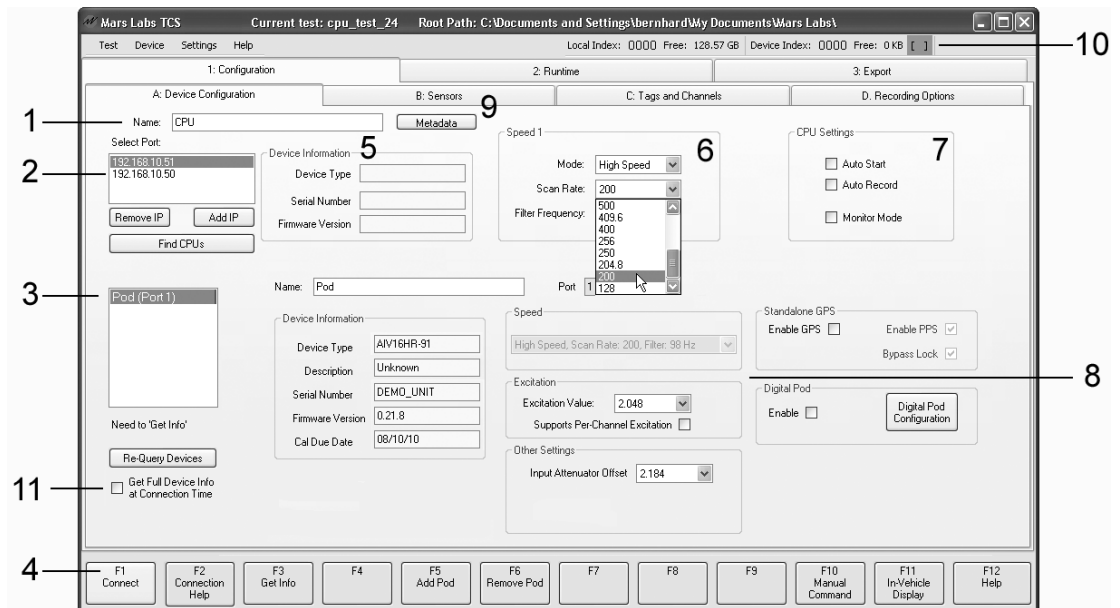

The components of the CPU Expander Device Configuration screen:

1. Name field – Allows you to specify a unique name for the device. This name appears in the channel list in the ‘Tags and Channels’ window.
2. ‘Select Port’ list – This list displays all connected Titan CPU Channel Expanders. Devices can be added or removed from the list using the associated buttons, and new hardware can be queried.
3. A list of connected Titan Devices. The list can be refreshed by clicking on the ‘ReQuery Devices’ button.
4. Function keys – In the CPU Expander Device Configuration window, the Function keys are assigned the following functions:

- [F1] - Connects/disconnects to the selected Titan CPU Expander
- [F2] - Displays the ‘Connectivity’ section of the TCS User Manual
- [F3] - Refreshes the CPU Expander Device Information display
- [F5] - Adds a Pod/Mini-Recorder
- [F6] - Removes a Pod/MiniRecorder
- [F10] - For issuing Manual Commands to connected devices
- [F11] - Invokes the In-Vehicle Display
- [F12] - Invokes the embedded TCS User Manual

5. ‘Device Information’ – Displays the information of the connected CPU, including device type, serial number, and firmware version.

NOTE: Users should heed the warning about mixing Titan device types.
For more information see CPU Configuration Issues in a Mixed Titan System, pg 152

6. ‘Speed’ – The drop-down menus in this CPU pane allow you to configure the device speed, scan rate and filter frequency of the connected hardware:

Mode - Selects Very High Speed, High Speed, or Low Speed operation.

Scan Rate - Sets the scan rate. The available scan rates are:

Very High Speed: 11,025 - 60,000 samples per second per channel

High Speed: 128 - 10,000 samples per second per channel

Low Speed: 10 - 1200 samples per second per channel

NOTE: Very High Speed (VHS) rates only apply to Titan II, Titan CAI, and Titan CPUxxV devices. For more information, refer to Appendix B Scan Rates and Supported Configurations

Filter Frequency - Sets the frequency of the anti-aliasing filter. The filter is automatically set to 0.49 of the scan rate for High Speed or Very High Speed operation. For Low Speed operation, the available filter frequency selections are: Bypassed, 5, 10, 20, 40, 50, 80, 100, 150, 200, 230, 250 Hz

7. CPU Settings - These checkboxes establish the Power-On condition of the CPU:

Auto Start: When checked, CPU Auto Start is enabled. Auto Start commands all connected Titan hardware to begin scanning when the CPU powers up.

Auto Record: When checked, CPU Auto Record is enabled. When Auto Record is enabled, the CPU will begin recording a dataset upon power-up.

Monitor Mode (see **NOTES** below): When checked, Monitor Mode is enabled. Monitor Mode prevents the CPU from altering device configurations on power-up. When Monitor Mode is enabled, the CPU will not query devices and will not send any commands to connected devices. Instead, it will load the configuration it used at the previous run and assume it is connecting to the same devices already running.

NOTES:

1. When Monitor Mode is enabled, TCS displays a yellow box around the CPU Settings pane along with a “Pods unsynchronized” message to alert that Pod data is no longer synchronized.

2. The Monitor Mode selection checkbox is normally greyed out by default. It is activated in the TCS Settings menu.(TCS Settings, pg 131).

8. Pod/Mini-Recorder device information. Information reported here corresponds to the device that is selected in the Device List (item 3 above). For specific information about Pod/Mini-Recorder configurations, see the Mini-Recorder Device Configuration section, pg 39.
9. 'Metadata' button - permits Metadata entries for the current test. For more on the Metadata function, see Metadata, pg 43.
10. Alarm Indicator - The Alarm Indicator illuminates when an input signal exceeds the alarm threshold set in TCS Triggers and when the Alarm Indicator is set to 'Toolbar'.

Get Full Device Info
at Connection Time

11. When the 'Get Full Device Info' box is checked, TCS will acquire the full system device information from the CPU and all connected devices at connection time. This information can be viewed by clicking on the 'Metadata' button and selecting 'Device Information'. Note, however, that for large channel-count systems this acquisition can take several minutes, which can be undesirable in situations where repeated testing includes many Connect/Disconnect cycles. For this reason, the default state of the box is unchecked.

To acquire the complete system device information after connecting to a CPU Channel Expander, click the 'Get Info' button [F3]. TCS will display a 'Please wait...' window and begin the acquisition process. While the acquisition is taking place, some Device Information fields will be blank and appear in RED. After the acquisition process has completed, the Device Information fields will be populated with the correct information. Any field that displays erroneous or unexpected information will continue to appear in RED.

Device Configuration - Titan CPX Expander

Configuring TCS for a CPX Expander system is a variation of configuring a single CPU, except that all connected CPUs must first be identified and selected before sensor and channel assignments can be made.

In TCS, click on the 'Find CPUs' button to display all connected CPUs. Select the address of the CPX Expander (in the example below 192.168.10.55) and click Connect [F1].

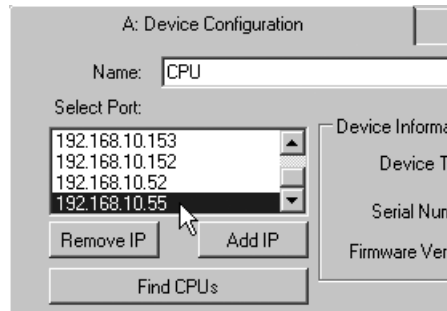

TCS will display a 'Virtual CPU' window that lists the addresses of all networked CPUs. Select the the CPUs that are connected to the Expander by checking the boxes of the appropriate IP addresses in the list:



NOTE: In the 'Virtual CPU' list, addresses are always sorted in ascending order, from lowest to highest.

After selecting the connected CPUs, click 'CONNECT'.

TCS will then query the devices, connect to the CPUs, and populate the Device Information fields:

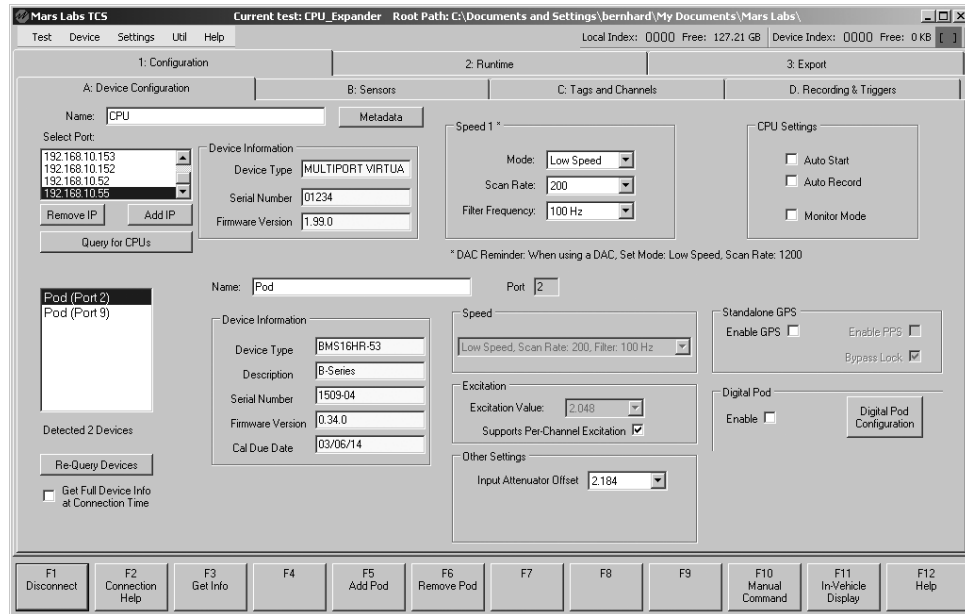

TCS assigns 8 'Pod' ports to each CPU connected to the Expander. The first CPU is assigned Pod ports 1-8, the second CPU is assigned Pod ports 9-16, the third CPU is assigned Pod ports 17-24, etc.. For a dual-CPU system (256 channels) as shown below, the first CPU has a Mini-Recorder physically connected in its port #2, while the second CPU has a Mini-Recorder physically connected in its port #1. As displayed in TCS, this configuration translates to Pod2 (Channels 1-16) and Pod9 (Channels 1-16):

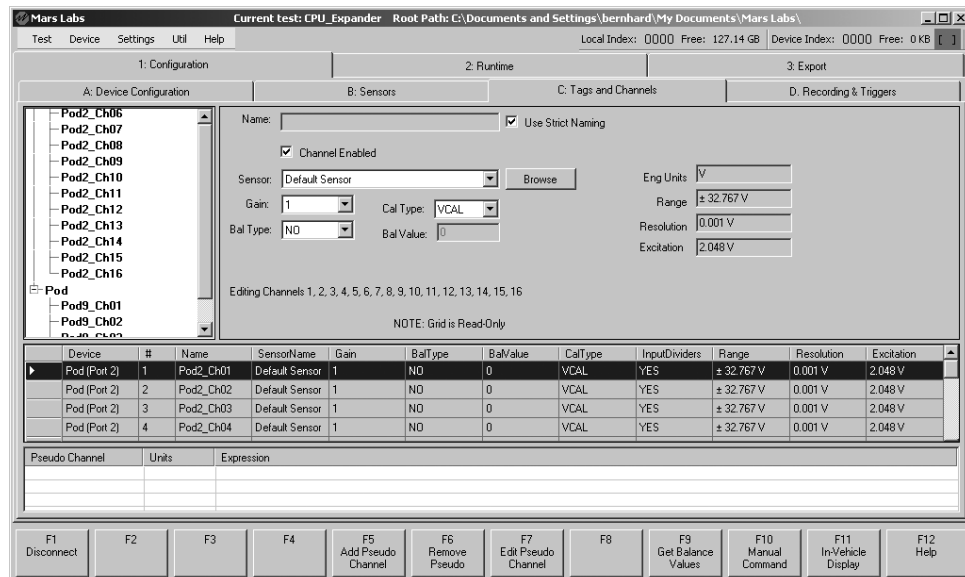

Configurations for individual channels are made using the 'Sensors', 'Tags and Channels' and 'Recording Options' screens as described herein.

Sensors - Analog

The *Sensors* screen is where you configure the analog sensors that are connected to the Titan device (digital sensors are treated separately - see page 80). The *Sensors* screen allows sensors to be individually named, cataloged and configured.

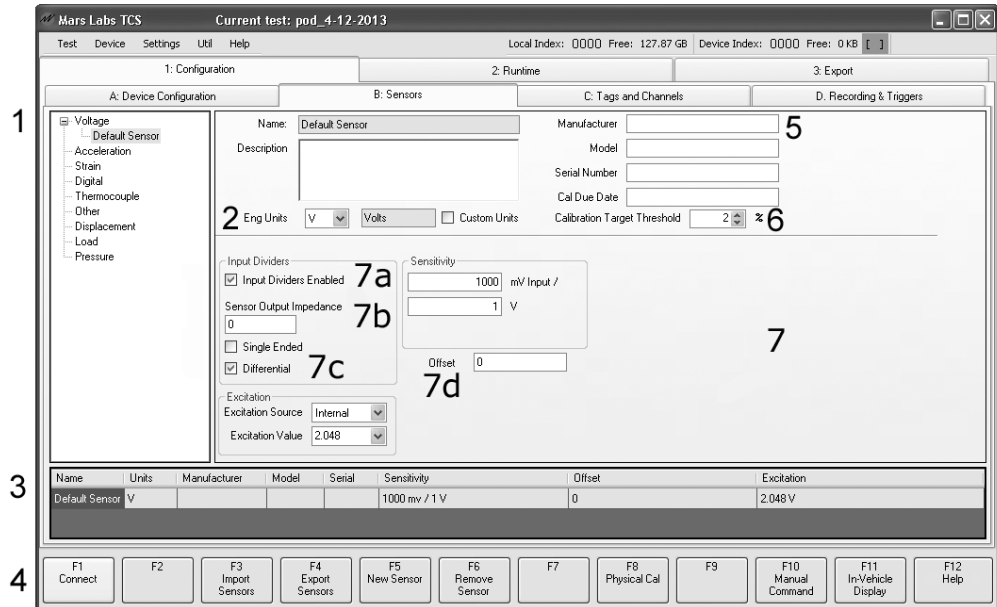

The main components of the *Sensors* screen are:

1. Sensor Tree – The Sensor Tree displays all defined sensors in TCS according to the sensor type (voltage, acceleration, strain, etc).
2. ‘Eng Units’ – A drop-down menu to select the engineering units for the output data. Items that appear in this menu are limited to the engineering units that are appropriate for the selected sensor type, but custom engineering units can also be defined.
3. Table of sensors. The table provides a non-editable overview of all defined sensors for a given sensor type (voltage, acceleration, strain, etc).
4. Function keys – In the Sensor window, Function keys are assigned as follows:

- [F1] - Connects/disconnects to the Titan device
- [F3] - Import Sensor
- [F4] - Export Sensor (see Sensor Import/Export, pg 72)
- [F5] - Adds a new sensor to the sensor list
- [F6] - Deletes a sensor from the sensor list
- [F8] - Physical Calibration (applies to all sensors except Strain, Frequency, Thermocouple and ‘Other’ sensor types)
- [F10] - For issuing Manual Commands to the Titan device
- [F11] - Switches to the In-Vehicle display
- [F12] - Invokes the embedded TCS User Manual

5. Text fields in the upper part of the pane allow you to enter basic information about the sensor (manufacturer, model, serial number & cal due date) plus additional information (sensor position, notes, etc.).
6. Calibration Target Threshold – Sets the Sensor Calibration Target tolerance, from 1% to 100%. The default for all sensors is 2%.
7. Fields in the lower part of the pane for sensor configuration. The fields and other information presented here will vary according to the type of sensor being configured, and may or may not include excitation or sensitivity.
 - 7a. ‘Input Dividers Enabled’ checkbox – Where applicable, this function physically enables the resistive divider network when using the sensor. Checking this box will divide the voltage across any channel using the sensor by a factor of 16.
 - 7b. Sensor Output Impedance – When Input Dividers are enabled, this field allows you to enter the output impedance of the sensor (applies to ICP Acceleration, Displacement, Sensitivity, Polynomial, Pressure, Strain and Voltage sensors).
 - 7c. ‘Single Ended/Differential’ checkboxes – When Input Dividers are enabled, these checkboxes allow you to select either single ended or differential sensor types (applies to ICP acceleration, displacement, sensitivity, polynomial, pressure, strain and voltage sensors).
 - 7d. Offset – This field allows you to enter an offset value in whatever engineering units are specified. The offset value is applied to the data after the transform. Offset values can be positive or negative.

Sensor Types

TCS supports ten types of analog sensors. In alphabetical order, they are:

Acceleration, Digital, Displacement
Load, Other - Sensitivity, Other- Polynomial
Pressure, Strain, Thermocouple & Voltage

Each sensor type has unique setup page in the Sensors Tab window. When you add a new sensor (by clicking on the ‘New Sensor’ button, or pressing F5), you will be prompted to select the type of sensor that you wish to add. Once the sensor type has been specified, the sensor setup page appears.

A description of each sensor setup pane follows.

Sensor Types - Acceleration

Related hardware connection diagrams (pg 161)

Titan devices support four types of acceleration sensors: ICP, Full Bridge, Solid State and Setra.

Field Definitions

Input Dividers Enabled: Enabled by default for ICP sensor types, optionally available for Solid State and Setra sensor types, and disabled for Full Bridge sensor types.

Type: Selects the type of acceleration sensor. This selection determines the configuration options that are presented in the lower part of the pane.

Sensitivity: Sensor translation from millivolts into engineering units. If excitation is specified the sensitivity equation is updated to include a value for the excitation.

Excitation Source: The excitation source for the sensor (Internal/External). This field is available for Full Bridge, Solid State and Setra sensor types. For ICP sensors, the excitation source is set for a constant current.

Excitation Value: The value in volts for the sensor excitation. When 'Per-Channel Excitation' is enabled, an excitation voltage from 2 to 11.5V can be selected.

Shunt Value: The value in ohms for the calibration resistor used to check the calibration of the sensor.

Gauge Resistance: The resistance of a single bridge of the sensor.

NOTE: The 'Excitation' and 'Shunt Calibration' panes only appear when Full Bridge, Solid State or Setra sensor types are selected

Sensor Types - Acceleration (cont.)

RCAL Target: The computed value (in engineering units) of the calibration target of the sensor. Enabling 'Manual RCAL' allows you to manually enter target values for CAL+ and/or CAL-. :

Shunt Calibration	
Shunt Value	100000
Gauge Resistance	350
<input type="checkbox"/> Manual RCAL - Target	
RCAL - Target	-0.873471
<input checked="" type="checkbox"/> Manual RCAL + Target	
RCAL + Target	0.88

Acceleration Sensor Transforms

$$ICP \text{ and Solid State : } f(x) = \frac{x * Units}{Sensitivity} + Offset$$

$$Full Bridge : f(x) = \frac{x * Units * (PerVolts / Excitation)}{Sensitivity} + Offset$$

Sensor Types - Digital

For Frequency Sensor connection diagrams, see pg 167

Titan devices support two types of digital sensors: Period and Totalizer.

Field Definitions

Input Dividers Enabled: Enabled by default and selectable.

Mode: Selects Period or Totalizer modes. The selection determines the configuration options that are presented in the lower part of the pane.

Timebase: Available only when Period mode is selected, this is the frequency range to be measured. Four ranges are available: 50 KHz, 100KHz, 500KHz, 1MHz.

Sensitivity: Sensor translation from millivolts into engineering units. For Period mode, the engineering units default is 'Hz'. For Totalizer mode, the engineering units default is 'cnts' (counts).

Measurement Range: Present only when Period mode is selected. The values displayed in these non-editable fields are dependent on the Timebase selection.

Excitation Source: The excitation source for the sensor: None, Internal, External. When 'None' is selected, the Excitation Value field is hidden.

Excitation Value: The value in volts for the sensor excitation. When 'Per-Channel Excitation' is enabled, an excitation voltage from 2 to 11.5V can be selected in the drop down menu.

Digital Sensor Transform

$$\text{Period Mode: } f(x) = \frac{\text{Timebase} * \text{Units}}{x * \text{Sensitivity}}$$

$$\text{Totalizer Mode: } f(x) = \frac{x * \text{Units}}{\text{Sensitivity}}$$

NOTES:

1. Digital sensors can only be assigned to channels 1, 8 or 16, and only one digital sensor can be assigned at a time.
2. When a Digital Sensor is selected, the GPS Pulse Per Second (PPS) option must be disabled in both the Device Configuration and the Digital Pod configuration screens.
3. Period measurements are valid to approximately 7K Hz.
4. In Totalizer mode, the maximum number of counts = 65535.

Sensor Types - Displacement

Titan devices support a variety of displacement sensors, all classified as Displacement.

Field Definitions

Input Dividers Enabled: Enabled by default and selectable.

Sensitivity: Sensor translation from millivolts into engineering units. If excitation is specified the sensitivity equation is updated to include a value for the excitation.

Excitation Source: The excitation source for the sensor: None, Internal, External. When 'None' is selected, the Excitation Value field is hidden.

Excitation Value: The value in volts for the sensor excitation. When 'Per-Channel Excitation' is enabled, an excitation voltage from 2 to 11.5V can be selected in the drop down menu.

Displacement Sensor Transform

$$\text{With Excitation set to None: } f(x) = \frac{x * \text{Units}}{\text{Sensitivity}} + \text{Offset}$$

$$\text{With Excitation On: } f(x) = \frac{x * \text{Units} * (\text{PerVolts} / \text{Excitation})}{\text{Sensitivity}} + \text{Offset}$$

For Displacement Sensor connection diagrams, see pg 165

Sensor Types - Load

For Load Sensor connection diagrams, see pg 161

Titan devices support many types of load sensors, all classified as Load.

Field Definitions

Input Dividers Enabled: Disabled and not selectable for Load sensors

Shunt Value: The value (in Ohms) for the calibration resistor used to check the calibration of the sensor.

Gauge Resistance: The resistance (in Ohms) of a single bridge of the load sensor.

RCal Target: The computed value for RCAL when the ‘Compute RCal Target’ button is pressed. The computed value is based on the values entered into the ‘Shunt Calibration’ and ‘Sensitivity’ fields. Enabling ‘Manual RCAL’ allows you to manually enter target values for CAL+ and/or CAL-. When a manual target value is specified, the ‘Compute RCal Target’ button is ignored for that target.

Sensitivity: Sensor translation from millivolts into engineering units. If excitation is specified the sensitivity equation is updated to include a value for the excitation.

Excitation Source: The excitation source for the sensor: None, Internal, or External. When ‘None’ is selected, the Excitation Value field is hidden.

Excitation Value: The value in volts for the sensor excitation. When ‘Per-Channel Excitation’ is enabled, an excitation voltage from 2 to 11.5V can be selected in the drop-down menu.

Load Sensor Transform

$$f(x) = \frac{x * Units * (PerVolts / Excitation)}{Sensitivity} + Offset$$

Sensor Types - Other - Sensitivity

Titan devices support two methods of defining additional (Other) sensor types: Sensitivity and Polynomial. The Sensitivity configuration is shown below. The Polynomial configuration is shown on the next page.

Field Definitions

Input Dividers Enabled: Enabled by default and selectable.

Transform Type: Selects either the Sensitivity or Polynomial transform.

Sensitivity: Sensor translation from millivolts into engineering units. If excitation is specified the sensitivity equation is updated to include the value for the excitation.

Excitation Source: The excitation source for the sensor: None, Internal, External. When 'None' is selected, the Excitation Value field is hidden.

Excitation Value: The value in volts for the sensor excitation. When 'Per-Channel Excitation' is enabled, an excitation voltage from 2 to 11.5V can be selected in the drop down menu.

Shunt Value: The value (in Ohms) for the calibration resistor used to check the calibration of the sensor.

Gauge Resistance: The resistance (in Ohms) of a single bridge of the sensor.

RCal Target: The computed value (in engineering units) of the calibration target of the sensor based on the Shunt Value and Gauge Resistance. Enabling 'Manual RCAL' allows you to manually enter target values for CAL+ and/or CAL-.

Sensor Transform

$$\text{Sensitivity Mode with Excitation Enabled: } f(x) = \frac{x * \text{Units} * (\text{PerVolts} / \text{Excitation})}{\text{Sensitivity}}$$

$$\text{Sensitivity Mode with Excitation set to None: } f(x) = \frac{x * \text{Units}}{\text{Sensitivity}}$$

Sensor Types - Other - Polynomial

The Polynomial configuration is shown below.

The screenshot shows the configuration interface for a Polynomial sensor. The top section contains fields for Name (OtherSensor1), Description, Manufacturer, Model, Serial Number, Cal Due Date, and Calibration Target Threshold (2%). Below this, there are sections for Input Dividers (checked), Sensor Output Impedance (0), Single Ended (unchecked), Differential (checked), and Excitation Source (None). The Polynomial section includes a dropdown for Transform Type (Polynomial) and a grid of coefficient input fields for orders x^0 through x^7, with an Offset field set to 0.

Field Definitions

Input Dividers Enabled: Enabled by default and selectable.

Transform Type: Selects either the Sensitivity or Polynomial transform.

Polynomial Coefficients: Enter a coefficient value for each Polynomial order.

This will be used to translate sensor millivolts to engineering units. Up to an eighth order polynomial may be entered.

Excitation Source: The excitation source for the sensor: None, Internal, External.

When 'None' is selected, the Excitation Value field is hidden.

Excitation Value: The value in volts for the sensor excitation. When 'Per-Channel Excitation' is enabled, an excitation voltage from 2 to 11.5V can be selected in the drop down menu.

Sensor Transform

Applies the given polynomial.

NOTE: For Polynomials, the specified polynomial is applied to the raw reading in mV. Excitation is not accounted for.

Sensor Types - Pressure

Titan devices support Full Bridge and Solid State pressure sensors.

Field Definitions

Input Dividers Enabled: Optionally available for Solid State sensors; disabled for Full Bridge sensor types.

Type: Selects Full Bridge or Solid State

Sensitivity: Sensor translation from millivolts into engineering units. If excitation is specified the sensitivity equation is updated to include a value for the excitation.

Excitation Source: Selects the excitation source for the sensor (Internal/External).

Excitation Value: The value in volts for the sensor excitation. When ‘Per-Channel Excitation’ is enabled, excitation voltages from 2 to 11.5V can be selected for Solid State (range limited 2 to 7.5V for Full Bridge)

Shunt Value: The value in ohms for the calibration resistor used to check the calibration of the sensor.

Gauge Resistance: The resistance of a single bridge of the sensor.

RCAL Target: The computed value (in engineering units) of the calibration target of the sensor. Enabling ‘Manual RCAL’ allows you to manually enter target values for CAL+ and/or CAL-.

Pressure Sensor Transform

$$\text{With Excitation set to None: } f(x) = \frac{x * \text{Units}}{\text{Sensitivity}} + \text{Offset}$$

$$\text{With Excitation On: } f(x) = \frac{x * \text{Units} * (\text{PerVolts} / \text{Excitation})}{\text{Sensitivity}} + \text{Offset}$$

Sensor Types - Strain

For Strain Sensor connection diagrams, see pg 161

Titan devices support full, half, and quarter bridge strain gauge sensors.

The screenshot shows the configuration interface for a strain sensor. Key fields include:

- Name:** StrainSensor1
- Description:** (empty text area)
- Manufacturer:** (empty text field)
- Model:** (empty text field)
- Serial Number:** (empty text field)
- Cal Due Date:** (empty text field)
- Eng Units:** μE (selected), MicroStrain, Custom Units
- Calibration Target Threshold:** 2 %
- Input Dividers:** Input Dividers Enabled
- Gauge Parameters:**
 - Gauge Resistance: 350
 - Active Arms: 1
 - Gauge Factor: 2
 - Poisson's Ratio: 0.26
 - Note: Gauge factor may be negative based on the physical sensor configuration
- Shunt Calibration:**
 - Shunt Value: 100000
 - Manual RCAL - Target
 - RCAL - Target: -1746.94
 - Manual RCAL + Target
 - RCAL + Target: 1746.94
- Excitation:**
 - Excitation Source: Internal
 - Excitation Value: 2.048
- Offset:** 0

Field Definitions

Input Dividers Enabled: Disabled and not selectable.

Gauge Resistance: The resistance (in Ohms) of a single bridge of the strain gauge.

Number of Active Arms: The number of active arms the strain gauge is using:

- 1 arm = Quarter bridge
- 2 arms = Half bridge
- 4 arms = Full bridge

Gauge Factor: The gauge factor of the strain gauge. The gauge factor may be negative based on the physical sensor configuration.

Poisson's Ratio: The ratio of decrease in thickness (lateral contraction) to its increase in length (logitudinal extension) under load for a given material. A value of 0.26 is the nominal value for steel; for other materials, consult the manufacturers data sheet (this selection is not currently implemented).

Excitation Source: The excitation source for the sensor (Internal or External).

Excitation Value: The value in volts for the sensor excitation. When 'Per-Channel Excitation' is enabled, an excitation voltage (2 to 11.5V) can be selected.

Shunt Value: The value (in Ohms) for the calibration resistor used to check the calibration of the sensor.

RCAL Target: The computed value (in engineering units) of the calibration target of the sensor. The computed value is based on the values entered for the 'Shunt Value' and 'Gauge Parameter' fields. Enabling 'Manual RCAL' allows you to manually enter target values for CAL+ and/or CAL-.

Strain Sensor Transform

$$\text{One Active Arm: } f(x) = \frac{4x}{\text{Excitation}} + \text{Offset}$$

$$\text{Two Active Arms: } f(x) = \frac{-2x}{\text{Excitation}} + \text{Offset}$$

$$\text{Four Active Arms: } f(x) = \frac{-x}{\text{Excitation}} + \text{Offset}$$

Note: The strain sensor also adjusts for units mE and E.

For more on strain gauge sensor theory, operation, and configuration in TCS, refer to Applications Note APN-1008 - Strain Gauge Fundamentals & Configuration in TCS.

Sensor Types - Thermocouple

Titan devices support three types of thermocouples: J, K and T.

The screenshot shows a configuration window for a thermocouple sensor. It has several input fields and checkboxes. The 'Name' field contains 'ThermoSensor1'. The 'Eng Units' section has radio buttons for '°C', 'Degrees Celciu', and 'Custom Units'. The 'Calibration Target Threshold' is set to 2%. The 'Input Dividers' section has a checkbox for 'Input Dividers Enabled' which is unchecked. The 'Offset' field is set to 0. The 'Thermocouple Type' dropdown is set to 'J'.

Field Definitions

Input Dividers Enabled: Disabled and not selectable.

Thermocouple Type: Selects J, K, or T type thermocouples. Titan devices support the following ranges of each Thermocouple type:

J: -210 to 1200 degrees C

K: -200 to 1372 degrees C

T: -200 to 400 degrees C

Sensor Transform

Thermocouple transforms are pre-defined eight-order polynomials that are defined for each thermocouple type. The transforms are shown on the following pages.

NOTE: When a Thermocouple sensor is assigned to a channel in the Tags & Channels screen, the GAIN for that channel is automatically set to "64":

The screenshot shows a configuration window for a sensor channel. The 'Channel Enabled' checkbox is checked. The 'Sensor' dropdown is set to 'Thermocouple Type K'. The 'Gain' dropdown is set to '64'. The 'Cal Type' dropdown is set to 'VCAL'. The 'Bal Type' dropdown is set to 'NO'. The 'Bal Value' field is set to '0'. There is a 'Browse' button next to the 'Sensor' dropdown.

For Thermocouple Sensor connection diagrams, see pg 169

Sensor Types - Thermocouple (cont.)

Type K Transforms

```
*****
* This section contains coefficients of approximate inverse
* functions for type K thermocouples for the subranges of
* temperature and voltage listed below. The range of errors of
* the approximate inverse function for each subrange is also given.
* The coefficients are in units of °C and mV and are listed in
* the order of constant term up to the highest order.
* The equation is of the form  $t_{90} = d_0 + d_1 * E + d_2 * E^2 + \dots$ 
*   +  $d_n * E^n$ ,
* where E is in mV and  $t_{90}$  is in °C.
*
*   Temperature      Voltage      Error
*   range            range        range
*   (°C)             (mV)         (°C)
*   -200. to 0.      -5.891 to 0.000  -0.02 to 0.04
*   0. to 500.       0.000 to 20.644  -0.05 to 0.04
*   500. to 1372.    20.644 to 54.886  -0.05 to 0.06
*****
```

Inverse coefficients for type K:

Temperature	-200.	0.	500.
Range:	0.	500.	1372.
Voltage	-5.891	0.000	20.644
Range:	0.000	20.644	54.886
	0.0000000E+00	0.0000000E+00	-1.318058E+02
	2.5173462E+01	2.508355E+01	4.830222E+01
	-1.1662878E+00	7.860106E-02	-1.646031E+00
	-1.0833638E+00	-2.503131E-01	5.464731E-02
	-8.9773540E-01	8.315270E-02	-9.650715E-04
	-3.7342377E-01	-1.228034E-02	8.802193E-06
	-8.6632643E-02	9.804036E-04	-3.110810E-08
	-1.0450598E-02	-4.413030E-05	0.000000E+00
	-5.1920577E-04	1.057734E-06	0.000000E+00
	0.0000000E+00	-1.052755E-08	0.000000E+00
Error	-0.02	-0.05	-0.05
Range:	0.04	0.04	0.06

NOTE: Transform information shown on this page and following pages was obtained from the NIST Thermocouple database at <http://srdata.nist.gov>.

Sensor Types - Thermocouple (cont.)

Type T Transforms

```

*****
* This section contains coefficients of approximate inverse
* functions for type T thermocouples for the subranges of
* temperature and voltage listed below. The range of errors of
* the approximate inverse function for each subrange is also given.
* The coefficients are in units of °C and mV and are listed in
* the order of constant term up to the highest order.
* The equation is of the form  $t_{90} = d_0 + d_1 * E + d_2 * E^2 + \dots$ 
*    $+ d_n * E^n$ ,
* where E is in mV and  $t_{90}$  is in °C.
*
*      Temperature          Voltage          Error
*      range                range            range
*      (°C)                 (mV)         (° C)
*      -200. to 0.         -5.603 to 0.000   -0.02 to 0.04
*      .0 to 400.         0.000 to 20.872   -0.03 to 0.03
*****

```

Inverse coefficients for type T:

```

Temperature  -200.          0.
Range:        0.          400.

Voltage      -5.603       0.000
Range:       0.000       20.872

          0.0000000E+00  0.0000000E+00
          2.5949192E+01  2.592800E+01
          -2.1316967E-01 -7.602961E-01
          7.9018692E-01  4.637791E-02
          4.2527777E-01 -2.165394E-03
          1.3304473E-01  6.048144E-05
          2.0241446E-02 -7.293422E-07
          1.2668171E-03  0.0000000E+00

Error        -0.02       -0.03
Range:       0.04       0.03

```

Sensor Types - Thermocouple (cont.)

Type J Transforms

```
*****
* This section contains coefficients for type J thermocouples for
* the two subranges of temperature listed below. The coefficients
* are in units of °C and mV and are listed in the order of constant
* term up to the highest order. The equation is of the form
*  $E = \sum(i=0 \text{ to } n) c\_i t^i$ .
*
* Temperature Range (°C)
* -210.000 to 760.000
* 760.000 to 1200.000
*****
```

```
Name: reference function on ITS-90
Type: J
Temperature units: °C
EMF units: mV
```

```
Temperature
Range: -210.0 to 760.0

0.000000000000E+00
0.503811878150E-01
0.304758369300E-04
-0.856810657200E-07
0.132281952950E-09
-0.170529583370E-12
0.209480906970E-15
-0.125383953360E-18
0.156317256970E-22
```

```
Temperature
Range: 760 to 1200.0

0.296456256810E+03
-0.149761277860E+01
0.317871039240E-02
-0.318476867010E-05
0.157208190040E-08
-0.306913690560E-12
```

Sensor Types - Thermocouple (cont.)

Type J Transforms

```
*****
* This section contains coefficients of approximate inverse
* functions for type J thermocouples for the subranges of
* temperature and voltage listed below. The range of errors of
* the approximate inverse function for each subrange is also given.
* The coefficients are in units of °C and mV and are listed in
* the order of constant term up to the highest order.
* The equation is of the form  $t_{90} = d_0 + d_1E + d_2E^2 + \dots$ 
*   +  $d_nE^n$ ,
* where E is in mV and  $t_{90}$  is in °C.
*
* Temperature      Voltage      Error
* range           range         range
* (°C)            (mV)          (°C)
* -210. to 0.     -8.095 to 0.000  -0.05 to 0.03
* 0. to 760.      0.000 to 42.919  -0.04 to 0.04
* 760. to 1200    42.919 to 69.553 -0.04 to 0.03
*****
```

Inverse coefficients for type J:

Temperature	-210.	0.	760.
Range:	0.	760.	1200.
Voltage	-8.095	0.000	42.919
Range:	0.000	42.919	69.553
	0.00000000E+00	0.0000000E+00	-3.11358187E+03
	1.9528268E+01	1.978425E+01	3.00543684E+02
	-1.2286185E+00	-2.001204E-01	-9.94773230E+00
	-1.0752178E+00	1.036969E-02	1.70276630E-01
	-5.9086933E-01	-2.549687E-04	-1.43033468E-03
	-1.7256713E-01	3.585153E-06	4.73886084E-06
	-2.8131513E-02	-5.344285E-08	0.00000000E+00
	-2.3963370E-03	5.099890E-10	0.00000000E+00
	-8.3823321E-05	0.000000E+00	0.00000000E+00
Error	-0.05	-0.04	-0.04
Range:	0.03	0.04	0.03

Sensor Types - Voltage

For Voltage Sensor connection diagrams, see pg 164

Titan devices support many types of voltage sensors, all classified as Voltage.

The screenshot shows the configuration interface for a Voltage Sensor. The form is divided into several sections:

- General Information:** Name (Default Sensor), Description (empty), Manufacturer (empty), Model (empty), Serial Number (empty), Cal Due Date (empty).
- Units and Calibration:** Eng Units (V), Units (Volts), Custom Units (unchecked), Calibration Target Threshold (2 %).
- Input Dividers:** Input Dividers Enabled (checked), Sensor Output Impedance (0), Single Ended (unchecked), Differential (checked).
- Sensitivity:** Sensitivity (1000 mV Input /), Offset (0 V).
- Excitation:** Excitation Source (Internal), Excitation Value (2.048).

Field Definitions

Input Dividers Enabled: Enabled by default and selectable.

Excitation Source: The excitation source for the sensor: None, Internal, External.
When 'None' is selected, the Excitation Value field is hidden.

Excitation Value: The value in volts for the sensor excitation. When 'Per-Channel Excitation' is enabled, an excitation voltage from 2 to 11.5V can be selected in the drop down menu.

Voltage Sensor Transform

$$f(x) = \frac{x * Units}{Sensitivity} + Offset$$

This page intentionally left blank

Physical Calibration [F8]

Physical calibration (PCAL) allows you to establish sensor calibration parameters through the use of a known physical force or property. In effect, PCAL allows you to specify the relationship of a sensor output for a given input. This is desirable in those cases where the sensor calibration is unspecified or unknown, such as the output of a Load Cell for a given input load.

In TCS, physical calibration can be performed on all sensors except for Strain, Frequency, Thermocouple and 'Other' sensor types. The following examples illustrate how to perform a physical calibration using a Displacement sensor.

PCAL example

Let's begin by defining a new Displacement sensor. The default 'Sensitivity' values for a Displacement sensor are 1mV/1cm:

Select the PCAL function [F8], then select the Channel the sensor is assigned to, select the Gain, and the method of physical calibration (RCAL or Manual) for the desired sensor:

NOTE: Although the example above shows Gain = 1, the actual Gain setting used for PCAL should be the same gain as configured in the Tags and Channels screen.

For Manual PCAL:

Select 'START'. TCS will now read and display the raw input value from the sensor, and allow you to enter the value that the input corresponds to:

Physical Sensor Calibration (PCAL)

Current Raw Value: 0 mV

Channel: 1

Gain: 1

PCal Type: Manual

What does the current value correspond to?

0

Continue

Select 'CONTINUE'. Now apply a known input to the sensor. This will result in a new raw value being displayed. Enter the value that this input corresponds to, and then select 'APPLY':

Physical Sensor Calibration (PCAL)

Current Raw Value: 40 mV

Channel: 1

Gain: 1

PCal Type: Manual

Now set a new value.

What does the current value correspond to?

1

Apply

The 'Sensitivity' values for the Displacement sensor now reflect the values resulting from the physical calibration process. In this example, a 40mV input corresponds to a displacement of 1cm:

Name: Test

Description:

Manufacturer:

Model:

Serial Number:

Cal Due Date:

Eng Units: cm Centimeters Custom Units

Calibration Target Threshold: 2 %

Input Dividers:

Input Dividers Enabled

Sensor Output Impedance: 0

Single Ended

Differential

Excitation:

Excitation Source: Internal

Excitation Value: 2.048

Sensitivity:

40 mV Input /

1 cm

2.048 / V Excit.

Offset: 0

Based on the values chosen for this example, the Displacement sensor exhibits no offset:

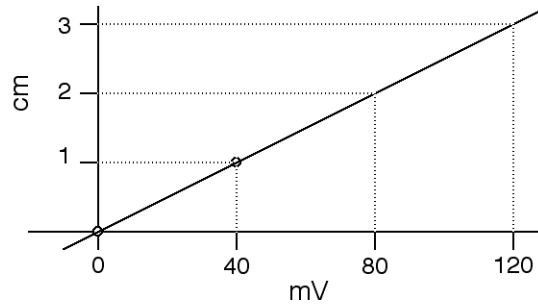

For RCAL:

Select 'START'. TCS will now read and display the raw input value from the sensor, and allow you to enter the value that the input corresponds to:

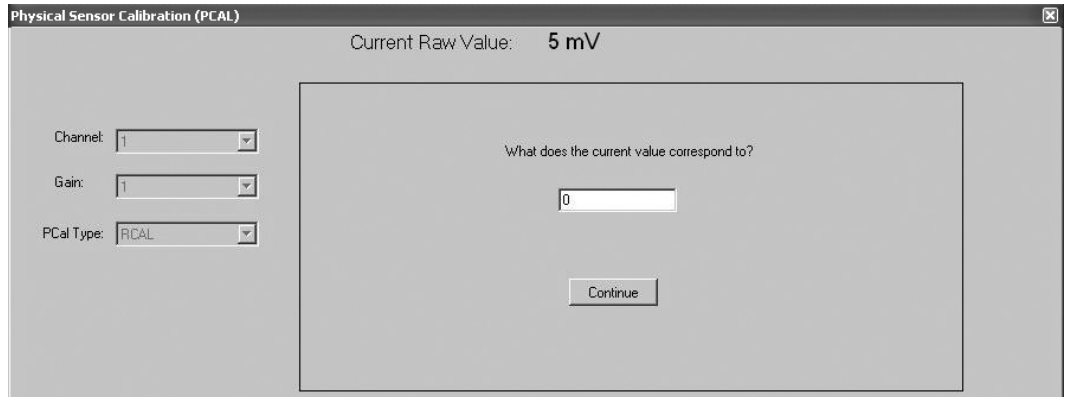

NOTE: RCAL is only valid for 2.048V excitation. Different excitation values will result in an invalid RCAL result.

Select 'CONTINUE'. For RCAL, shunt calibration is activated. Now apply a known input to the sensor. This will result in a new raw value being displayed. Enter the value that this input corresponds to, and then select 'APPLY':

The 'Sensitivity' values for the Displacement sensor now reflect the values resulting from the physical calibration process. Note also that the PCAL values used in this example produce a computed offset of -0.3684 cm:

Viewed graphically:

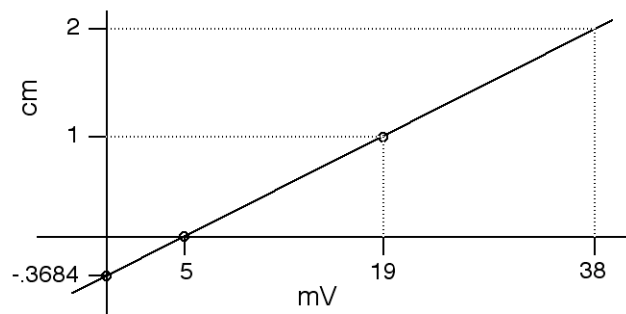

Sensor Import/Export

Sensor Import and Export functions appear on the button bar on the *Sensors* screen:

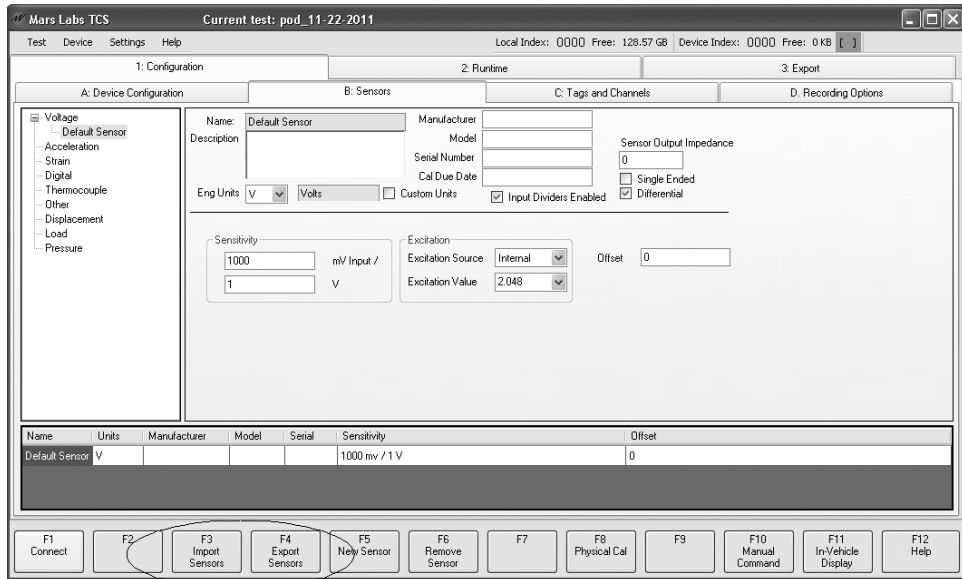

Clicking on the 'Import Sensors' button [F3] invokes the Import screen, while clicking on the 'Export Sensors' button [F4] invokes the Export screen. Only one screen can be accessed at a time.

Sensor Import

Selecting 'Import Sensors' brings up an Import window that allows you to select the files to be imported:

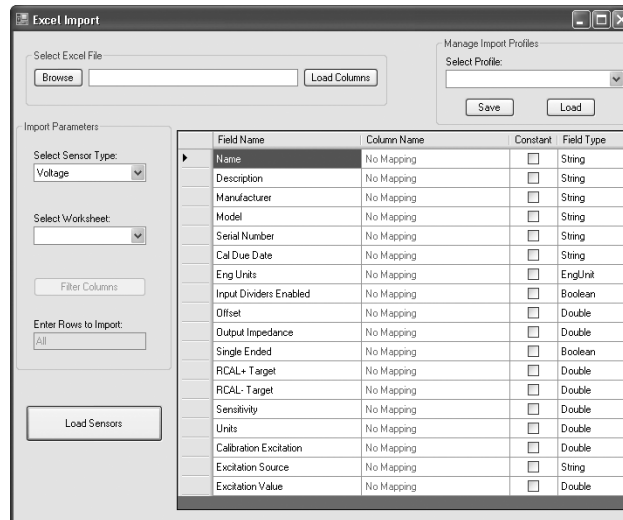

The first step in the Import process is to load the desired sensor database file. Click on the 'Browse' button (upper left) and navigate to the location of the source files. Select the file and click 'Open':

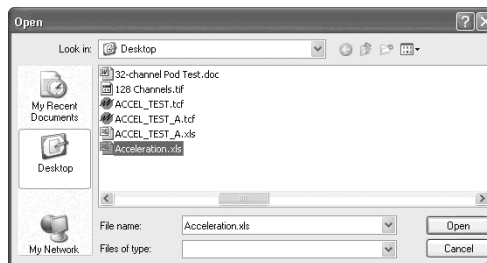

NOTES:

1. Sensor database files must be in the MSEXcel file (.xls) format on a single worksheet. MSEXcel files with multiple worksheets will produce an 'Index out of range error' when loaded.
2. Sensor database files should contain descriptive names for each column on the topmost row. These names will be used to map the information in each column with the fields in TCS:

	A	B	C	D	E
1	Name	Description	Manufacturer	Model	S/N
2	Strain Gage	Bi-axial Tee	ML Industries	MLSG-12	12345
3	Strain Gage	Bi-axial Tee	ML Industries	MLSG-23A	12346
4					

In the ‘Import Parameters’ section, select the desired sensor from the ‘Select Sensor Type’ dropdown. This will display the TCS fields that are appropriate for the selected sensor type.

Click on the ‘Load Columns’ button. This will load the column names from the sensor database that was just loaded.

The next step is to map the TCS field names to the names in the database file using the dropdown menus. If the sensor information you are importing was previously exported from TCS, the mapping will already be correct:

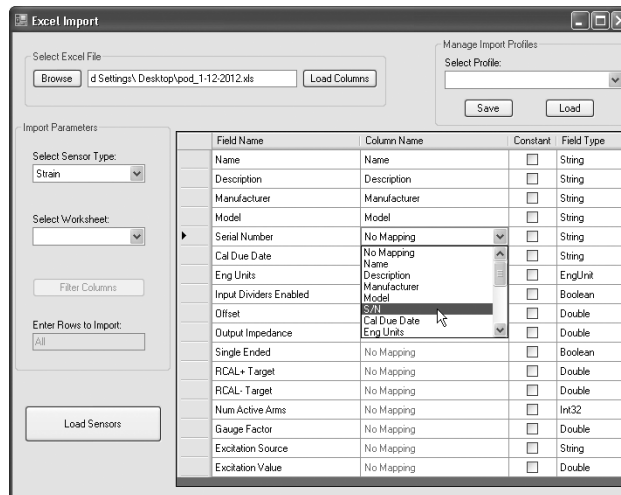

NOTE: For large sensor databases, the number of items that appear in the dropdowns can become considerable. To reduce the number of items that are displayed, it is suggested that you pre-sort your sensors into individual single worksheets organized by sensor type.

After the mapping operation is complete, click on ‘Load Sensors’ to get the list of available sensors. CTRL-Click to select the desired sensors for import, and then click on ‘Import Selected Sensors’:

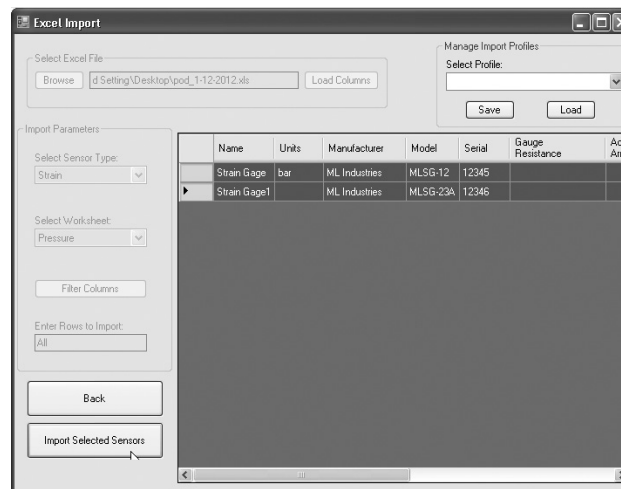

The selected sensors will be imported into TCS:

The screenshot shows the Mars Labs TCS software interface for configuring a sensor. The main window is titled "Mars Labs TCS" and "Current test: pod_1-12-2012". The interface is divided into several sections: A. Device Configuration, B. Sensors, C. Tags and Channels, and D. Recording Options. The "Sensors" section is active, showing configuration for a "Strain Gage".

Configuration details for the selected sensor:

- Name: Strain Gage
- Manufacturer: ML Industries
- Model: MLSG-12
- Serial Number: 12345
- Cal Due Date: (empty)
- Eng Units: μE (selected), MicroStrain, Custom Units
- Calibration Target Threshold: 2%
- Gauge Parameters: Gauge Resistance: 350, Active Arms: 1, Gauge Factor: 2, Poisson's Ratio: 0.26
- Shunt Calibration: Shunt Value: 100000, Manual RCal - Target: -1746.94, Manual RCal + Target: 1746.94
- Excitation: Excitation Source: Internal, Excitation Value: 2.048
- Offset: 0

A table at the bottom of the configuration window lists the configured sensors:

Name	Units	Manufacturer	Model	Serial	Gauge Resistance	Active Arms	Gauge Factor	Poisson's Ratio	Transverse Sens	Excitation Value	Shunt Cal Value
Strain Gage1		ML Industries	MLSG-23A	12346	350	1	2	0.26		2.048	100000
Strain Gage	μE	ML Industries	MLSG-12	12345	350	1	2	0.26		2.048	100000

At the bottom of the window, there are function keys: F1 Connect, F2, F3 Input Sensors, F4 Export Sensors, F5 New Sensor, F6 Remove Sensor, F7, F8 Physical Cal, F9, F10 Manual Command, F11 In-Vehicle Display, and F12 SerHelp p.

The table below shows the assignable field types in TCS, organized by sensor:

Assignable fields in TCS		Sensor Types									
		Accelerometer	Digital	Displacement	Load	Other - Sensitivity	Other - Polynomial	Pressure	Strain	Thermocouple	Voltage
Basic Sensor Information ¹							X				
Engineering Units ²							X				
Offset ³							X				
Input Dividers ⁴		X	X	X		X	X	X	X	X	X
Sensor Output Impedance (Ohms) ⁵		X		X		X	X	X	X	X	X
Single Ended/Differential Input		X		X		X			X	X	X
Sensitivity (Sensor Output per Engineering Unit)	Sensitivity Value	X		X	X	X	X	X	X		X
	Eng. Unit Value ('Units')	X		X	X	X	X	X	X		X
	Calibration (per V Excitation)	X		X	X	X	X	X	X		X
Type or Mode ⁶		X	X		X	X	X			X	
Excitation	Source (None/Int/Ext)	X		X	X	X	X	X	X		X
	Value (volts)	X		X	X	X	X	X	X		X
Gauge Resistance					X				X		
Active Arms (1/2/4)									X		
Gauge Factor									X		
RCAL+ Target (manual entry or computed value)		X			X				X		
RCAL- Target (manual entry or computed value)		X			X				X		

Notes:

1. *Basic Sensor Information* is information common to all sensor types, including Name, Description, Model, Manufacturer, Serial Number, and Cal Due Date.
2. *Engineering Units* supported in TCS include Amps (μA , mA, A), metric units (μm , mm, cm, m, km), Volts (μV , mV, V), Atmospheres (atm), Pressure (bar), Flow (cc/s), Counts (cnt), Acceleration (g), and Degrees per second.
3. The *Offset* value is always specified in *Engineering Units*.
4. *Input Dividers* is specified as a TRUE/FALSE condition that determines whether or not the Input Dividers are enabled in TCS for the selected sensor. When TRUE, Input Dividers are enabled; when FALSE, Input Dividers are disabled.

5. When *Input Dividers* are enabled, *Sensor Output Impedance* and *Single Ended/Differential Input* options can be specified. *Sensor Output Impedance* is specified in Ohms. The *Single Ended* option is a TRUE/FALSE selection. When TRUE, a Single-Ended input is specified; when FALSE, a Differential input is specified.
6. *Type or Mode* - This field specifies a selection of two or more options for a given sensor type within TCS. This field can be left blank for database imports.
7. During import, empty database fields will result in default value assignments in TCS.

Sensor Export

Any sensor or group of sensors configured in TCS can be exported and saved for later recall.

Consider the example below, where several accelerometer sensors have been configured:

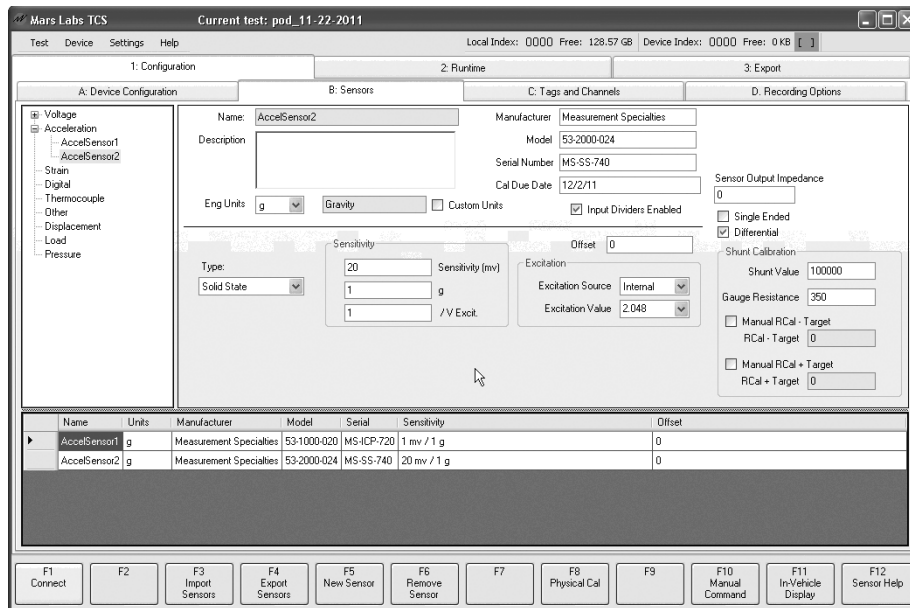

Clicking on the 'Export Sensors' button brings up a window that allows you to export the sensor information for an individual sensor or group of sensors configured in the current test:

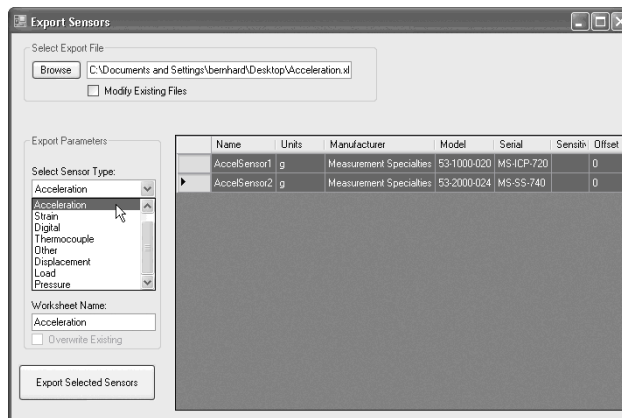

On the Export Sensor screen, sensors are grouped by type using the ‘Select Sensor Type’ dropdown menu. In the example above, selecting ‘Acceleration’ displays the two accelerometers in the sensor list. To export the sensors, CTRL-Click to select both sensors and then click on the ‘Export Selected Sensors’ button. The file will be exported with the file name (and location) shown in the ‘Select Export File’ field.

The exported file can be opened using MS Excel or a comparable spreadsheet application. Viewing the file reveals the sensor information and configuration that was exported:

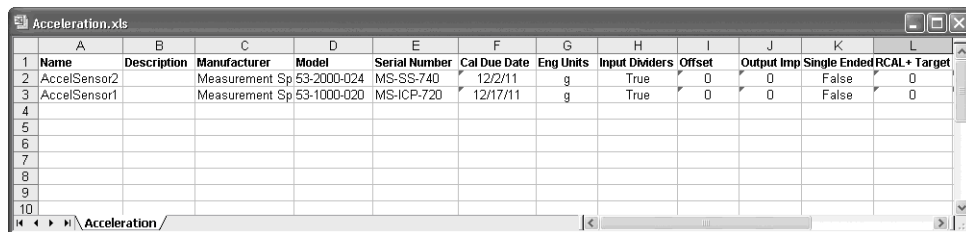

	A	B	C	D	E	F	G	H	I	J	K	L
1	Name	Description	Manufacturer	Model	Serial Number	Cal Due Date	Eng Units	Input Dividers	Offset	Output Imp	Single Ended	RCAL + Target
2	AccelSensor2		Measurement Sp	53-2000-024	MS-SS-740	12/2/11	g	True	0	0	False	0
3	AccelSensor1		Measurement Sp	53-1000-020	MS-ICP-720	12/17/11	g	True	0	0	False	0
4												
5												
6												
7												
8												
9												
10												

NOTE: When multiple sensor types are being exported with the same file name, each sensor type is saved on a separate worksheet, i.e. Voltage sensors will appear on a Voltage worksheet, Accelerometers will appear on an Accelerometer worksheet, etc. Worksheet names always default to the sensor type, but can freely be renamed. To export sensors to individual files (not worksheets), change the name in the ‘Select Export File’ field for each sensor type.

Sensors - Digital

Digital sensors are configured on the *Device Configuration* screen by enabling the and clicking on the Digital Pod Configuration button:

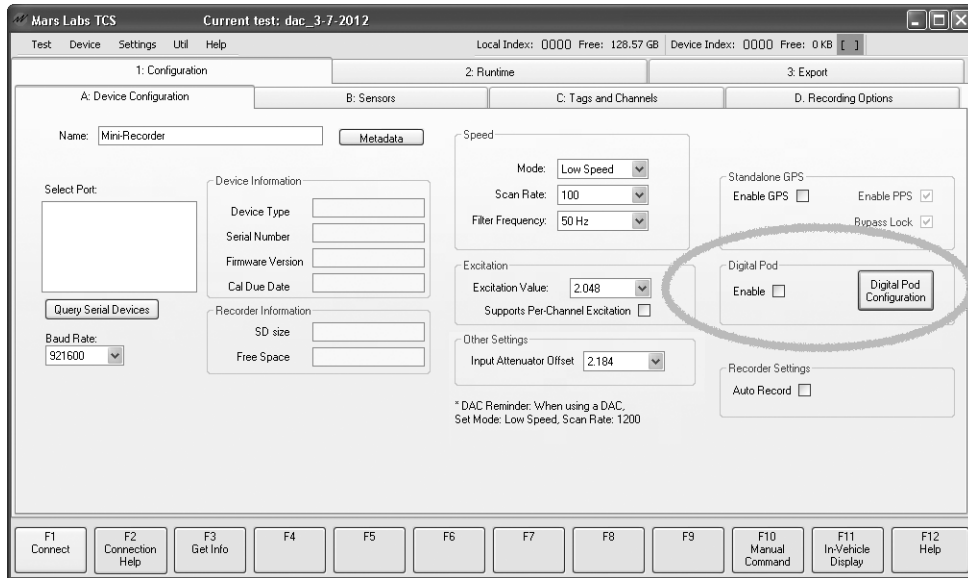

Mini-Recorder screen (similar for DAC screen)

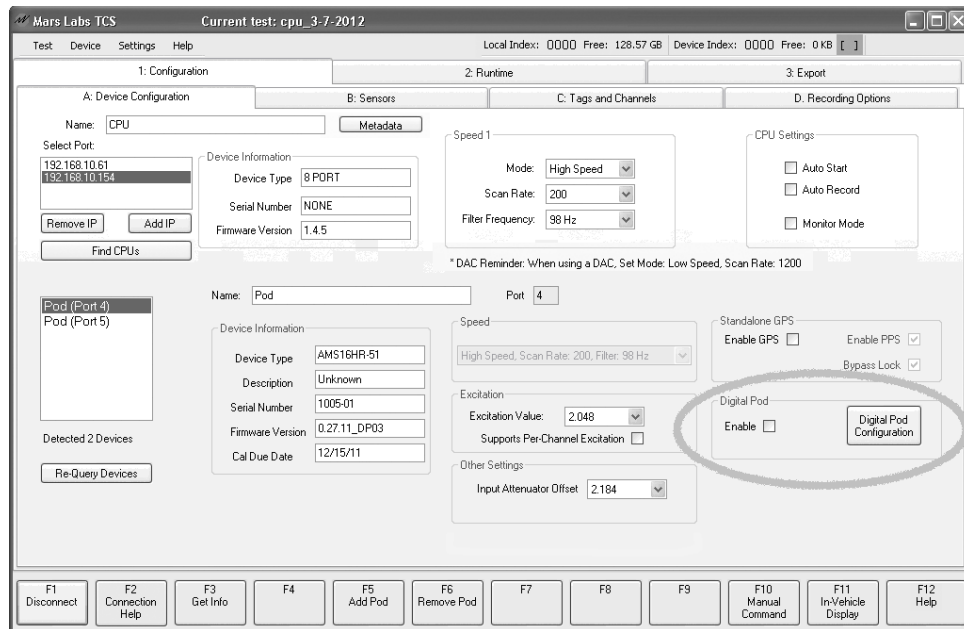

Titan CPU screen

When the Digital Pod 'Enable' box is checked, TCS sets up the communication parameters for the Digital Pod and adds information fields to the *Device Configuration* screen as shown:

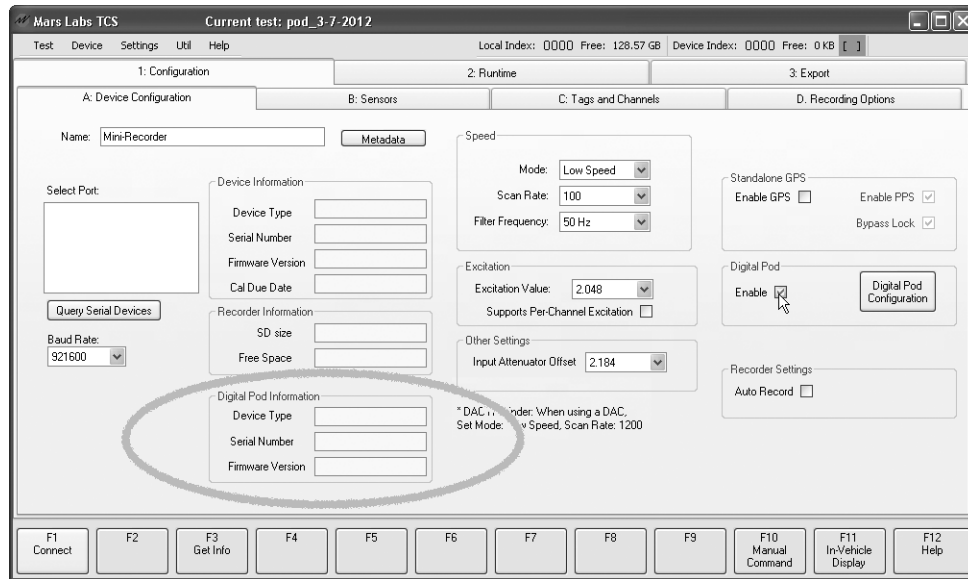

Mini-Recorder screen

Clicking on the 'Digital Pod Configuration' button produces a configuration window where you enable and define CAN ports, GPS, and Serial inputs. A CAN Channel Definition management utility for DBC files is also enabled here:

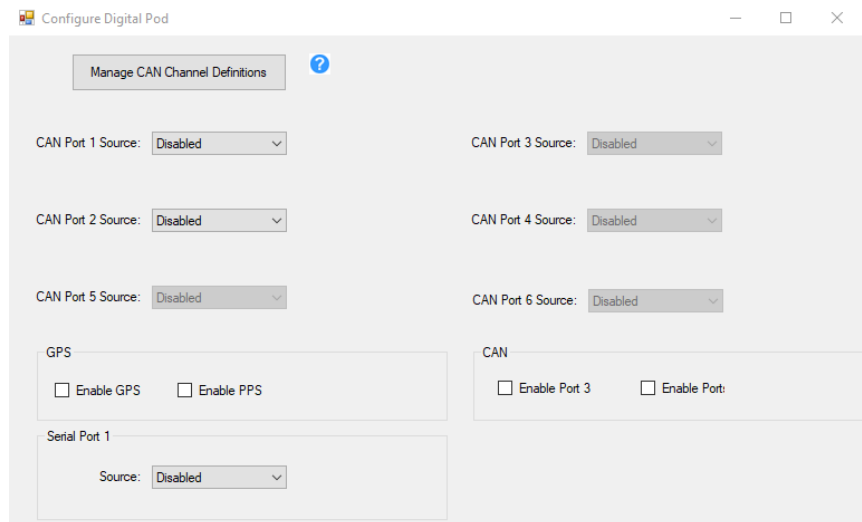

NOTE: The Digital Pod supports both ISO CAN and non-ISO CAN protocols. **The factory default setting is ISO CAN.** Any CAN port can be switched between ISO CAN and Non-ISO CAN modes. For more information, refer to *Appendix C - Changing the CAN Mode.*

Managing CAN Channel Definitions

The 'Manage CAN Channels Definitions' button produces a configuration window that allows you to select and manage channel definitions in DBC files:

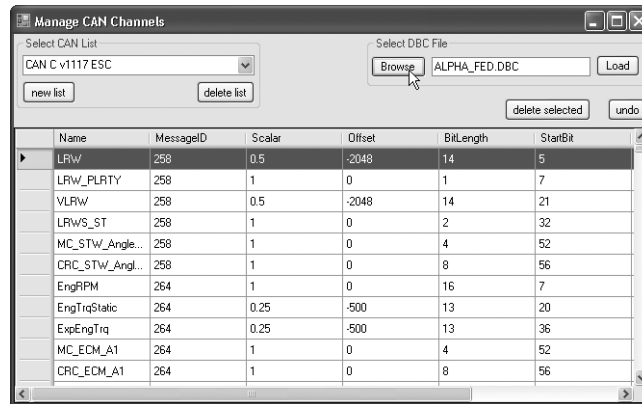

CAN Channel Management Window controls:

Browse – Selects the DBC file

Load – Loads the selected DBC file into TCS

Select CAN List – A dropdown that displays the DBC files that have been loaded

New List, Delete List, Delete Selected and Undo – Functions not yet implemented

NOTE: When configuring the Digital Pod for Wheel Force Transducers, you will need to load the associated DBC file into the CAN Management window prior to configuring the WFT.

Configuring CAN Port Sources

CAN Port Sources are selected from a dropdown menu:

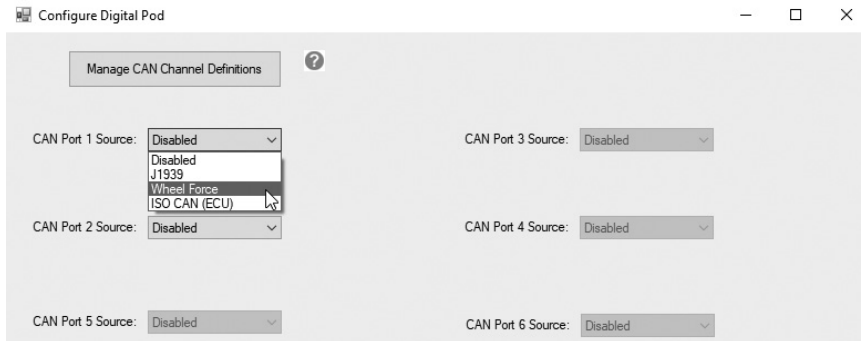

After choosing a CAN Port source, a Baud Rate selection dropdown appears along with a button to access the configuration options for the selected source ('Configure ISO CAN', 'Configure WFT' or 'Configure J1939'), and checkboxes for Enable Silent and Enable ISO FDCAN (see NOTES below).

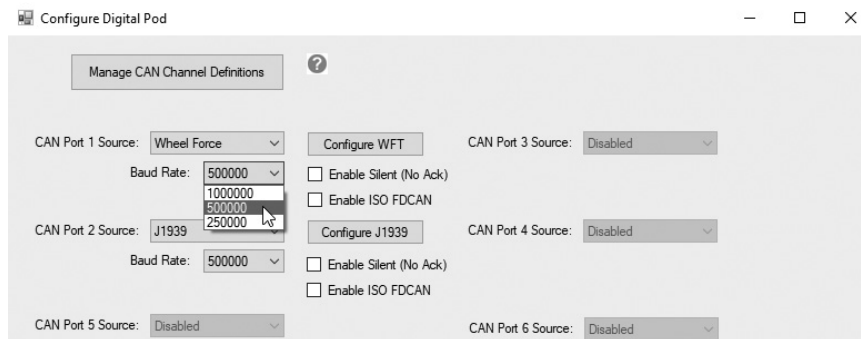

The recommended Baud Rate setting is dependent on the chosen CAN source:

- For J1939: 250,000
- For WFT: 500,000
- For ISO CAN: 500,000 or 250,000

The configuration options for each CAN Port Source, as well as the GPS and Serial Port selections, are described below.

NOTES:

1. **Enable Silent** - The CAN channels on Digital Pods default to NORMAL mode. Normal mode allows the hardware to automatically send acknowledgements upon the reception of CAN frames. In some situations, however, you may want to monitor the CAN bus without interacting with it, or simply stop issuing acknowledgements for other reasons. For these situations, enabling SILENT mode prevents acknowledgement messages from being issued.
2. **Enable ISO FDCAN** - The CAN channels on Digital Pods default to the classic CAN protocols. Enabling ISO FDCAN enables CAN Flexible Data Rate (CAN FD) protocols that support multiple data rates and variable message sizes.
3. **ISO/non-ISO** - The Digital Pod supports both ISO and non-ISO CAN protocols. The factory default setting is ISO CAN. Any CAN port can be switched between ISO and Non-ISO CAN modes. Refer to Appendix C - Changing the CAN Mode.

ISO CAN

The 'Configure ISO CAN' button produces a configuration window that allows you to assign ECU channels as shown. Up to ten ECU channels can be assigned:

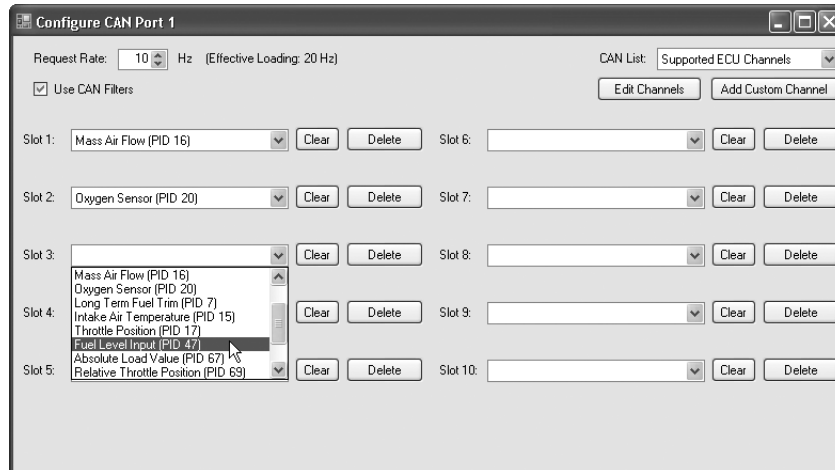

Managing CAN Channel Definitions

ISO CAN is request-based; that is, the system will not receive any data unless it asks for it. Because of that, you must define the channels that the Digital Pod will request, and how frequently it will issue requests. There is a practical limit to how frequently a CAN bus can be requested, which is determined by the effective loading: one request for each channel, multiplied by the request rate. If your system requests too frequently, the CAN bus will be overloaded and you will receive no data. Mars Labs has determined that a reasonable request rate with most cars is 10 Hz, effective loading. Your system may be able to handle more frequent requests - this will give you more data points. To change the request rate, use the Request Rate field in the top left of the form.

TCS comes with several pre-defined channels from the list of standard Parameter Identifiers (PIDs). Not all cars implement all of these channels, but the list is provided as a starting point to creating tests with ISO CAN. This is the list that is selected by default as the source of channel definitions, since there are no user-defined channels when you start TCS.

To enable a channel, click on the dropdown associated with the slot you wish to use as shown above. You will see a list of channels in the currently selected set of definitions. Click on the one you want to use.

Defining a Custom Channel

To define a custom channel, click on the ‘Add Custom Channel’ button at the top right of the ISO CAN configuration window. In the ‘New ISO CAN Channel’ window, you must specify all of the components that make up an ISO CAN channel. An exception here is the ‘Units’ field, which TCS uses to display the data; ‘Units’ is not integral to the data collection in the way other fields are.

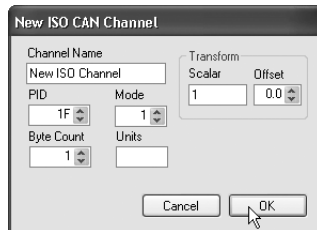

PID (Parameter Identifier) is the unique number identifying the channel, specified in hex.

‘Mode’ is the CAN mode; a value of 1 indicates ‘show current’, which is usually correct, unless you need to configure something that is manufacturer-specific.

‘Byte Count’ refers to the number of data bytes in each message from the ECU.

The transform group defines how to handle the data in each message in the format ‘(scalar * data) + offset’.

Editing a Custom Channel

To change a custom channel that is already defined, click on the ‘Edit Channels’ button on the ISO CAN configuration window. This will launch a new window, allowing you to select from the list of user-defined channels and edit their values:

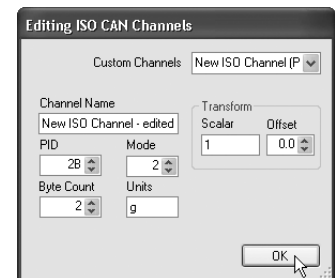

Selecting Custom Channels

To assign a custom channel to a slot, select ‘Custom Channels’ from the CAN list dropdown in the upper right corner. This will change the available selection in the slot dropdowns from predefined to custom channels:



Any assigned slot can be cleared by clicking on the associated ‘Clear’ button. If the slot contains a custom channel, that channel can be deleted by clicking on the associated ‘Delete’ button.

NOTE: The ‘Delete’ button will not remove a predefined channel.

Wheel Force Transducer

The ‘Configure WFT’ button produces a configuration window where you assign channels to individual wheel force elements:

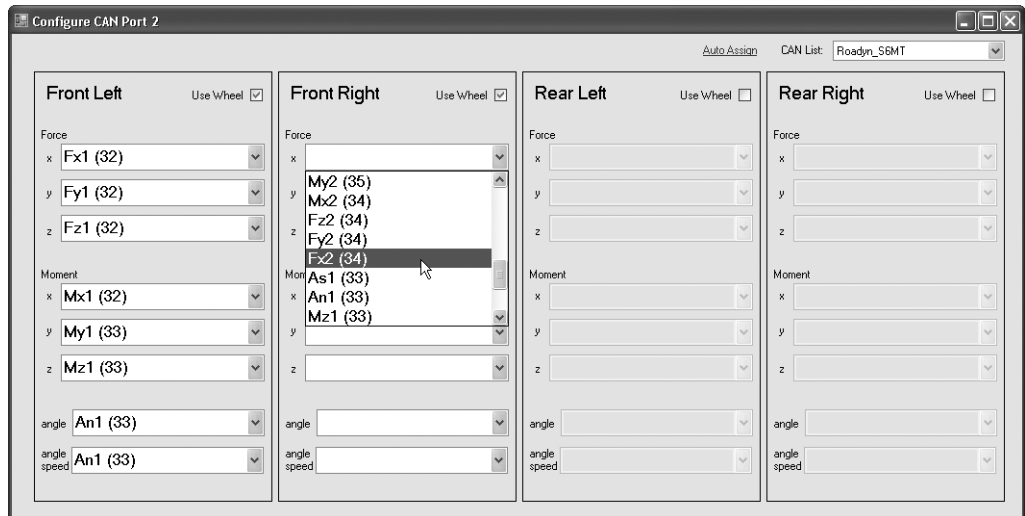

The parameters that appear in the dropdowns are derived from the ‘CAN List’ DBC selection in the upper right corner.

NOTE: Listings that appear in the ‘CAN List’ dropdown are loaded into TCS from the ‘Manage CAN Channel Definitions’ window

If the channel names in the selected DBC file match the field labels in TCS, clicking on the ‘Auto Assign Channels’ button will automatically map the proper channels to all wheels, eliminating the need for individual assignments.

After all channel assignments are complete, clicking on the close box enters the assignments into TCS. Channel assignments are stored when the test is saved.

NOTE: The WFT window supports configurations for 3 forces, 3 moments, the angle, and angle speed for each wheel. To specify additional associated with Wheel Force configurations that are not covered in the WFT window, e.g. acceleration, use the J1939 configuration window as an alternate for WFT configurations.

WFT Configuration Window Controls:

CAN List – A dropdown to select DBC files

Auto Assign Channels – A button that automatically assigns the proper channels when the channel names in the DBC file match TCS field labels

‘Use Wheel’ – Checkboxes to enable/disable selected wheel tables

J1939

The 'Configure J1939' button produces a configuration window that allows you to load an existing DBC file, select/delete channels, edit field values (shown below), or define additional channels by manually entering the data (an example of manual entry appears on the following page):

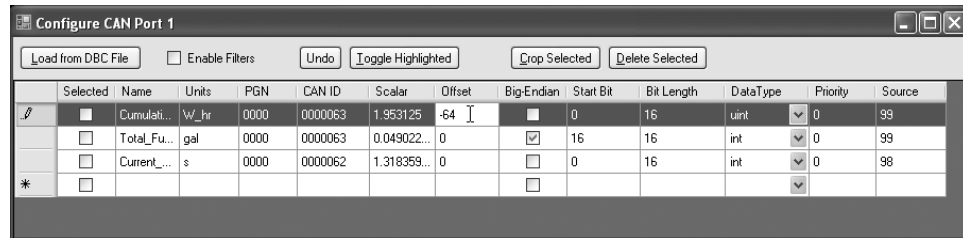

NOTE: The CAN ID value comprises the Priority, Parameter Group Number (PGN) and Source values. The Can ID value is displayed in Hex. The PDU is formatted as two bytes in Hex and represents the PDU Format and PDU Specific values.

The 'Data Type' drop-down menu selects signed integer ('int') or unsigned integer ('uint') values:

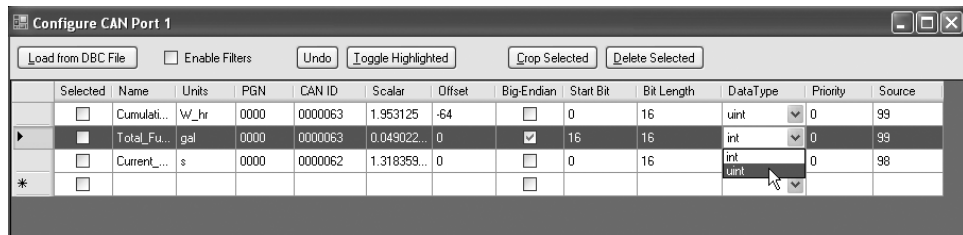
**Channel Selections**

To select contiguous channels in DBC files, select the first channel, hold the SHIFT key and then select the last channel. All channels between these two points will be selected. To make non-contiguous 'island' selections, hold the CTRL key while clicking on desired channels. After making selections, use the 'Crop' or 'Delete' buttons to trim the list to the desired test configuration.

J1939 Configuration Window Controls:

Load from DBC File – Allows you to select and load a DBC file

Enable Filters – When checked, this sets up filters based on the message ID for each configured J1939 channel.

Undo – Undo the last action

Toggle Highlighted – Toggles all selected channels ON/OFF.

Crop Selected – Retains selected channel definitions and deletes all others

Delete Selected – Deletes selected channel definitions

After all channel assignments are complete, clicking on the Close box enters the assignments into TCS. Channel assignments are stored when the test is saved.

J1939 - Manual Entry

To add a manual entry to an existing DBC file, scroll to the bottom of the file and make the entry in the field marked by the asterisk (*):

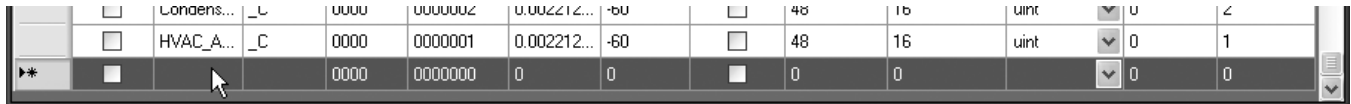

An example of manual entry of several J1939 channels from a data sheet:

PGN 65253 Engine Hours, Revolutions

Transmission Repetition Rate : on request
 Data Length : 8
 Reserve Bit : 0
 Data Page : 0
 PDU Format : 254
 PDU Specific : 229
 Default Priority : 6
 Parameter Group Number : 65253 (0xFEE5)

Start Position	Length	Parameter Name	SPN
1-4	4 bytes	Total engine hours	247
5-8	4 bytes	Total engine revolutions	249

With ECU simulated parameter value

Total engine hours: 0 to 210554060.75h 0.05h/bit. We give the value according to actual running time.
 Total engine revolutions: 0 to 4211081215000r 1000r/bit. We give the value according to engine speed and actual running time.

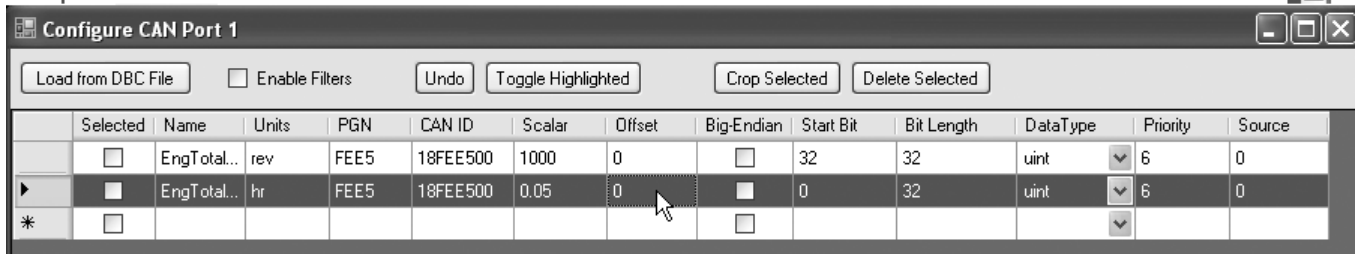

Note that the TCS Start Bit is the bit position of the channel message. If the data sheet lists the Start Position instead of the Start Bit (as shown above), the Start Bit is computed as:

$$(\text{Start Position} - 1) * 8$$

For example, a Start Position of '5' translates to a Start Bit value of '32':

$$(5 - 1) * 8 = 32$$

Note that the Bit Length parameter in TCS is specified in bits, not bytes. Note also that the Parameter Group Number (PGN) is entered as a decimal value. TCS converts the value to Hex and automatically computes the CAN ID value using the PGN, Priority and Source values.

GPS

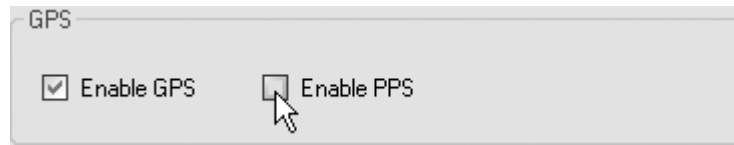

Checking the 'Enable GPS' box enables the Digital Pod's GPS port to accept data from a Garmin LX18X 5 Hz sensor.

Checking the 'Enable PPS' box enables the Digital Pod's GPS port to accept Pulse Per Second data from the Garmin LX18X 5Hz sensor.

NOTES:

1. Whenever the GPS/PPS option is enabled in the Digital Pod, PPS must also be enabled on the Device Configuration page. If the PPS option is not selected, PPS data exports will not increment as expected.
2. If the GPS sensor loses satellite lock during recording, the accuracy of synchronization functions that rely on Pulse Per Second (PPS) data may be affected and cannot be guaranteed. The typical drift when lock is lost is approximately 5 msec/hour. If GPS satellite lock is lost during recording, you should review the file if you are using PPS.

Serial Port

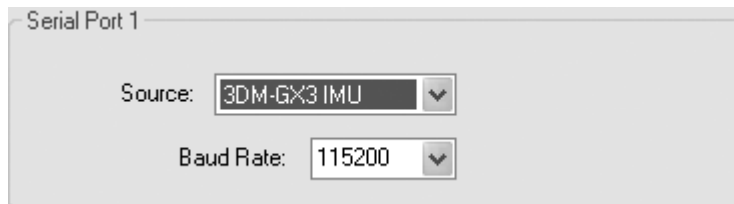

Serial port sources are selected from a dropdown menu in the Serial Port pane. Support is provided for the 3DM-GX3-25 and 3DM-GX5-25 IMU devices. The baud rate setting for these devices is fixed at 115,200, which means that you will need to configure your IMU device to stream data at the same rate.

As configured at the factory, Mars Labs' supplied 3DM IMU's are configured for a fixed data rate of 125 samples/second. This means that the selected scan rate in TCS must be set higher than 125s/s. Scan rates of less than 125 s/s will result in multiple IMU scans that will cause in discontinuities in the IMU data.

NOTE: Since the Digital Pod configuration screen is much smaller than the TCS window, it's possible for the Digital Pod configuration screen to fall behind the TCS window, appearing to be closed. Since changes to the Digital Pod configuration do not take place in TCS until the configuration screen is closed, it's possible to make changes without the changes actually taking effect. For this reason, always be sure to close the Digital Pod configuration screen after making assignments or changes.

Tags and Channels

The *Tags and Channels* screen is where you configure the input channels of the connected Titan device by assigning each channel to a sensor.

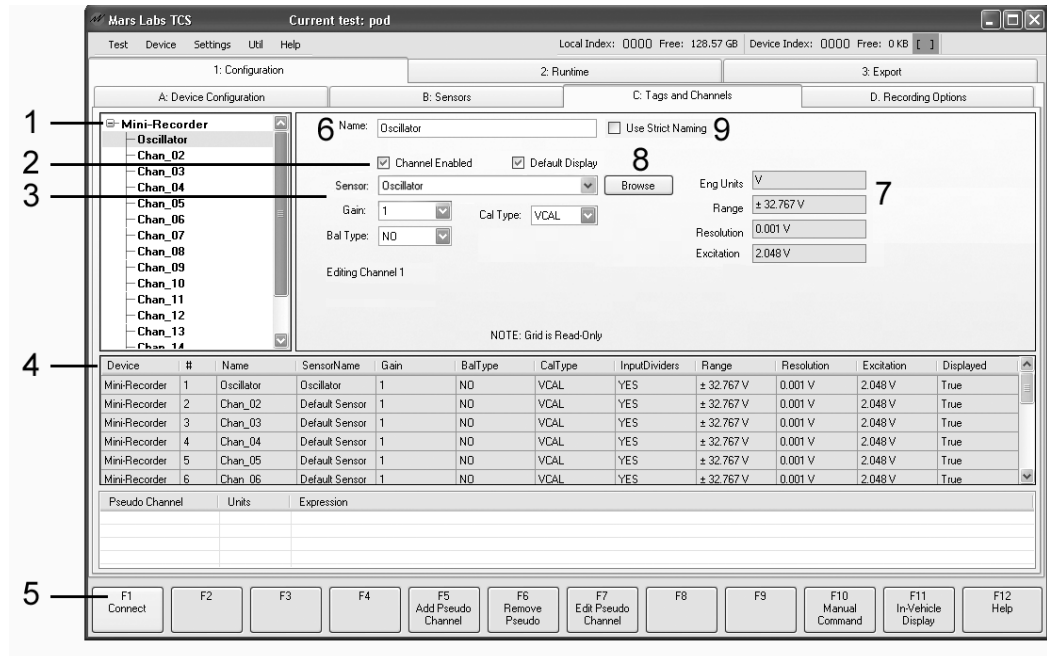

The main components of the *Tags and Channels* screen are:

1. Channel Tree – The Channel Tree displays all defined channels.
2. ‘Channel Enabled’ checkbox – Enables/disables selected channels. .
3. ‘Default Display’ checkbox - Enables/disables display of selected channels in the Export Review window. This is convenience feature to enable display of only the desired channels when working with large-channel count data sets.
3. Sensor Settings – The drop-down menus in this section allow you select and configure the sensor channel assignments.

Sensor – Assigns a sensor to the selected (highlighted) channel. All sensors that appear in this drop-down list are configured in the ‘Sensors’ configuration window.

Gain – Sets the gain for the selected channel. The available gain settings are from 1 to 512, provided in both normal and inverted versions.

NOTE: *Inverted gains are only supported on Titan devices with firmware version 0.34.20 or higher installed.*

Cal Type – Selects the calibration options:

VCAL (Voltage Calibration) – Places half-scale voltage on the input

RCAL (Shunt Calibrator) – Places a 100K resistor in parallel with the input

EXT – Keeps the signal on the input when using external calibration

Bal Type - Specifies the Balance enable option for the selected channel (the Balance function simply removes channel offsets). The options are 'YES', 'NO', and 'PREV' (Previous). If 'YES', then Balance will be applied to that channel when the Balance function [F10] is selected in the Runtime screen. If 'NO', then Balance will not be applied to the channel when the Balance function is selected. If 'PREV', then the last stored Balance offset (or the offset loaded with the test) will be applied when the Balance function is selected.

The Bal Type selection affects the connected device as follows:

YES: Offsets are cleared when the device powers up. New offsets are calculated and applied when a balance operation is performed. Balance values will persist as long as the device is powered up.

NO: Offsets are cleared when the device powers up. No offsets are applied at runtime.

PREV: The last stored offsets are loaded at power up and applied at runtime. New offsets are calculated and applied when a balance operation is performed. Balance values will persist across power cycles as long as the channel is set to PREV and the offsets are stored.

For more information on Balance, refer to Applications Note APN-1020 - The Balance function in TCS.

NOTES:

1. Balance values can be stored by selecting the 'Save Offsets' button in the Runtime screen, or by stopping and then re-starting the device scan after a balance operation has been performed.

2. Balance values are only valid for the gain, divider setting, and excitation values when the balance operation was performed. A new balance operation should be performed when any of these parameters (or the sensor connected to the channel) changes. TCS will display a warning message below the Bal Type field when the values are invalid and a new balance operation should be performed:

Gain: 1 Cal Type: VCAL
Bal Type: YES
Warning: need to balance.

4. Table of defined channels and pseudo channel grid. The table provides a non-editable status overview of all enabled channels for the current test (by default, each channel is initially assigned to voltage sensor with default values). The grid that appears below the table displays the defined pseudo channels.
5. Function keys – In the Tags and Channels window, [F1] is used to connect and disconnect to the selected Titan device. [F5], [F6] and [F7] support Pseudo Channel operations (see pg 94). [F10] allows you to issue Manual Commands to the connected device (the F10 button duplicates the ‘Send Manual Command’ selection found in the DEVICE menu) [F12] invokes the embedded TCS User Manual.
6. Channel Name field – Allows you to assigned a unique name for each channel.
7. Displays sensor information inherited from the ‘Sensors’ configuration window.

NOTES:

1. To configure all channels globally, click on the Titan device label at the top of the Channel Tree:

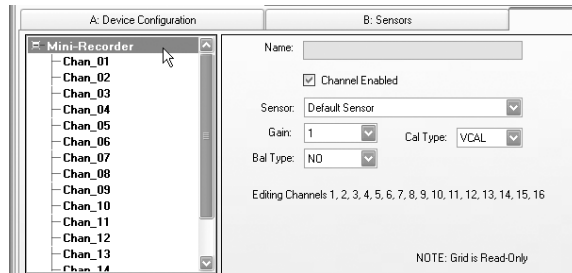

2. To make ‘island’ selections in the Channel Tree, hold the CTRL key while selecting the desired channels:

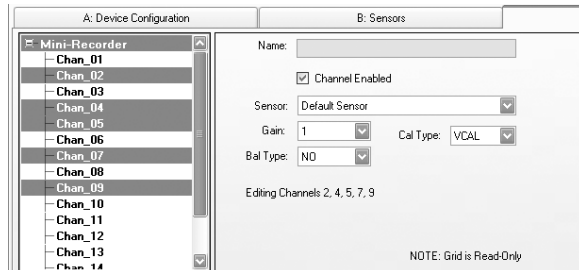

8. 'Browse' button - Displays a list of all available sensors for the current test. The list can be sorted by Type, Model or Name:

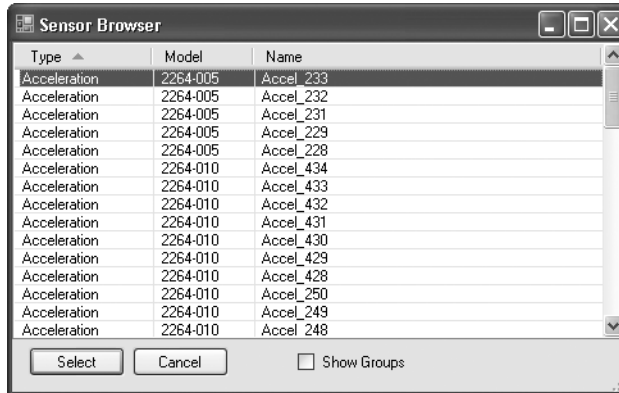

Enabling the 'Show Groups' checkbox reorganizes the display to sort by groupings of sensor Type (voltage, accelerometer, strain, etc.), Model or Name:

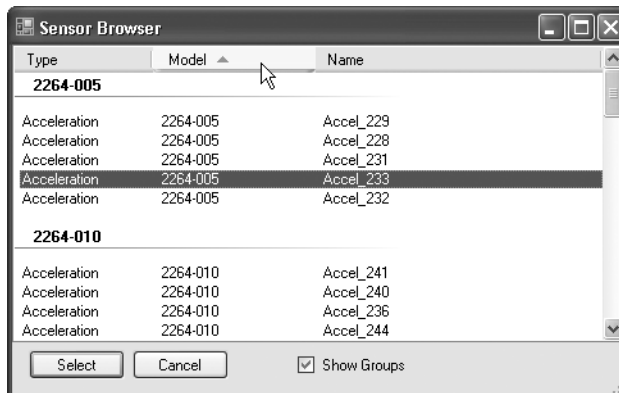

To assign a sensor to the currently selected channel, choose a sensor from the list and double-click or press 'Select'.

9. 'Use Strict Naming' checkbox - Enables/disables strict naming. When enabled, strict naming disallows channel names that are in conflict with Pseudo Channel and TCS Trigger naming conventions. Names must begin with a letter or underscore, and may only contain letters, numbers and underscores. Also, names cannot be functions or constants as defined in the Pseudo Channel or TCS Triggers list.

When 'Use Strict Naming' is enabled, a warning message will appear if you attempt to assign a disallowable channel name. Channel names that contain disallowable characters will be omitted from the channel lists in Pseudo Channels and TCS Triggers.

Pseudo Channels

A pseudo channel is a virtual channel created in TCS that is the result of a mathematical treatment of one or more physical TCS channels. A simple example of a pseudo channel would be subtracting one channel from another in order to observe the differences between them, such as obtaining the delta between two temperature sensors.

Pseudo channels are defined by mathematical expressions using a common syntax. For example, consider the following expression:

$$\text{Chan_01} + (\text{abs}(\text{Chan_02}) + \text{abs}(\text{Chan_03})) / 2$$

In this example, 'Chan_01', 'Chan_02' and 'Chan_03' are the actual channel names in TCS, and 'abs' is the 'absolute value' function. In this abstract example the signals of Chan_02 and Chan_03 are rectified, summed, and averaged, and then the value of Chan_01 is added to the result.

The expression syntax follows the standard order of mathematical operations regarding the use of parenthesis, followed by multiplication/division, and then addition/subtraction calculations. Parenthesis can always be added to expressions to add clarity, but may be unnecessary in some expressions where the precedence and operator associations are already clear.

For Pseudo Channel expressions, the available Operators are:

Operator	Definition	Precedence	Association
+	Addition	1	left to right
-	Subtraction	1	left to right
*	Multiplication	2	left to right
/	Division	2	left to right
%	Modulus	2	left to right
^	Power	3	right to left
- (unary minus)	Negation	4	right to left

NOTE: *Unary plus is not supported*

The available Constants are:

Constant	Value
E	2.71828182845904523536
PI	3.14159265358979323846
SQRT2	1.41421356237309504880
LOG2E	1.44269504088896340736
LOG10E	0.434294481903251827651
LN2	0.693147180559945309417
LN10	2.30258509299404568402

The available Functions are:

Function	Argument	Definition
sin(a)	1 (radians)	Sine
cos(a)	1 (radians)	Cosine
tan(a)	1 (radians)	Tangent
deg(a)	1	Convert degrees to radians
rad(a)	1	Convert radians to degrees
asin(a)	1	Arcsine
acos(a)	1	Arccosine
atan(a)	1	Arctangent
atan2(y, x)	2 (y, x)	Corresponds to C/C++ atan2
sinh(a)	1	Hyperbolic sine
cosh(a)	1	Hyperbolic cosine
tanh(a)	1	Hyperbolic tangent
ln(a)	1	Natural logarithm (to base e)
log2(a)	1	Logarithm to base 2
log10(a)	1	Logarithm to base 10
exp(a)	1	Exponential function (e^a)
sqrt(a)	1	Square root
sign(a)	1	-1 if $a < 0$, 0 if $a = 0$, 1 if $a > 0$
abs(a)	1	Absolute value
min(a, b)	2	Minimum value of a and b
max(a, b)	2	Maximum value of a and b
floor(a)	1	Round a value downwards to the nearest integer
ceil(a)	1	Round a value upwards to the nearest integer
round(a, ndigits)	1	Round a value to a specified number of fractional digits (ndigits)
count(a)	1	Increments the counter when the logical expression is true
env_abs(a, rel time)	2	An envelope follower function with zero attack time and a user-specified release time (in seconds). The function simulates a circuit with a rectifier bridge followed by a capacitor and resistor in parallel. Permits tracking the amplitude of an AC signal over time.
env_rms(value, time)	2	Produces the average (root mean square) within the specified time window (in seconds).
lpf1(value, cutoff)	2	A first order (-6dB/oct) low pass filter. The cutoff frequency is specified in Hertz.
hpf1(value, cutoff)	2	A first order (-6dB/oct) high pass filter. The cutoff frequency is specified in Hertz.

Numerical values also have common syntax in decimal-point or exponential form. For example:

```
23
1.5543
6.626068E-34.
```

Channel data values are identified by using the actual channel names. For example:

```
“Chan_01”
“1_Ch_2”
“Right_wheel_accel”
“Engine_temperature_sensor”
```

It is important to understand that the expression parser must be able to distinguish between the numeric values, channel names, and reserved words for function and constants; channel names such as “123” or “sin” are thus incorrect and cannot be used in pseudo channel expressions. In other words, channel names cannot be parseable numbers or reserved keywords.

The pseudo channel engine has no information about value scales or units; the physical meaning of these is left to the user. It is important to understand that there are no automatic conversions from millivolts to volts, grams to pounds, etc. To combine channels with different scales into a common unit result, it must be reflected in the expression. For example, to add a channel that displays in millivolts to a channel that displays in volts, divide the first channel value by 1000 before adding the channels:

$$\text{Chan_mV}/1000 + \text{Chan_V}$$

The result will then be in volts.

Creating Pseudo Channels

Pseudo channels are created in the ‘Tags and Channels’ screen. To create a pseudo channel, press F5 (‘Add Pseudo Channel’). This will produce a window (shown below) allowing you to define a pseudo channel. To assist in the expression definition process, the window also displays the available operators, functions, and constants, along with an example of the expression syntax:

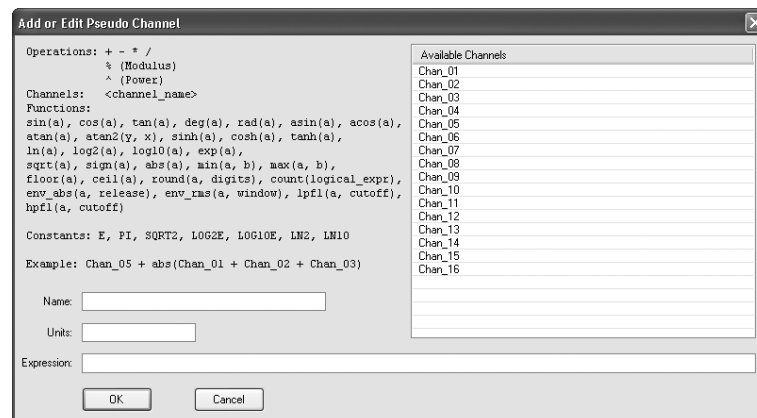

NOTE: Channel names that contain disallowable characters are omitted from the channel list in Pseudo Channels.

To create a pseudo channel, begin by entering the desired pseudo channel name into 'Name' field. All pseudo channels *must* be assigned a name - if no name is entered an error message will be displayed when you exit the window.

In the 'Units' field, enter the unit label of the pseudo channel (Volts, MPH, dB, etc.). The 'Units' field is optional and can remain empty if desired.

In the 'Expression' field, enter the desired expression. To select channels, double-click on the list of available channel names, or enter the channel name manually. Note that channels that are not enabled in the 'Tags and Channels' screen will not appear in the list. Mathematical operators, functions, and /or constants must be entered manually. You do not have to leave spaces between operators and/or functions in the expression, but you may find that it aids in clarity. If the expression contains a mathematical error, an error message screen will appear when you press 'OK'; if a channel name is entered incorrectly, however, no error message will be displayed.

NOTE: If a channel name is entered incorrectly, TCS will display an error message when you start a scan. To eliminate potential errors in channel names, always select channels from the channel name list instead of manual entry.

Each new pseudo channel will be added to the data grid at the bottom of the Tags and Channels screen. Pseudo channel names, units and expressions will appear as they were entered:

The screenshot displays the Mars Labs TCS software interface. The main window is titled "Current test: pod_3-12-2013". The interface is divided into several sections:

- Configuration Tabs:** 1: Configuration, 2: Runtime, 3: Export.
- Sub-sections:** A: Device Configuration, B: Sensors, C: Tags and Channels, D: Recording & Triggers.
- Mini-Recorder List:** A list of channels from Chan_01 to Chan_16. Chan_01 is selected.
- Channel Configuration:**
 - Name: Chan_01
 - Channel Enabled:
 - Sensor: Default Sensor
 - Gain: 1
 - Cal Type: V/CAL
 - Bal Type: NO
 - Bal Value: 0
 - Eng Units: V
 - Range: ± 32.767 V
 - Resolution: 0.001 V
 - Excitation: 2.048 V
- Channel Table:**

Device	#	Name	SensorName	Gain	BalType	BalValue	CalType	InputDividers	Range	Resolution	Excitation
Mini-Recorder	1	Chan_01	Default Sensor	1	NO	0	V/CAL	YES	± 32.767 V	0.001 V	2.048 V
Mini-Recorder	2	Chan_02	Default Sensor	1	NO	0	V/CAL	YES	± 32.767 V	0.001 V	2.048 V
Mini-Recorder	5	Chan_05	Default Sensor	1	NO	0	V/CAL	YES	± 32.767 V	0.001 V	2.048 V
Mini-Recorder	6	Chan_06	Default Sensor	1	NO	0	V/CAL	YES	± 32.767 V	0.001 V	2.048 V
Mini-Recorder	7	Chan_07	Default Sensor	1	NO	0	V/CAL	YES	± 32.767 V	0.001 V	2.048 V
Mini-Recorder	8	Chan_08	Default Sensor	1	NO	0	V/CAL	YES	± 32.767 V	0.001 V	2.048 V
- Pseudo Channel Section:**

Pseudo Channel	Units	Expression
AvgS	MPH	(Chan_05 + Chan_06 + Chan_07 + Chan_08)/4
dB_Chan1	dB	20 * log10(Chan_01 + 0.0000001)
Channel 2 counter	counts	count(Chan_02 > 0)
- Function Keys:** F1 Connect, F2, F3, F4, F5 Add Pseudo Channel, F6 Remove Pseudo, F7 Edit Pseudo Channel, F8, F9 Get Balance Values, F10 Manual Command, F11 In-Vehicle Display, F12 Help.

To remove a pseudo channel, select the channel in the grid and press F6. To edit a pseudo channel, double-click on the selected channel, or press F7.

NOTE: After defining all Pseudo Channels, it's recommended that you save the test prior to running.

Pseudo channel values are displayed only in the runtime plot and digital monitor screens in the Runtime environment, and in the digital data display in the InVehicle screen. For the digital monitor screens, pseudo channels appear in a shade of blue to distinguish them from other data values. The examples below show the same pseudo channel data displayed in various screens.

Runtime Plot:

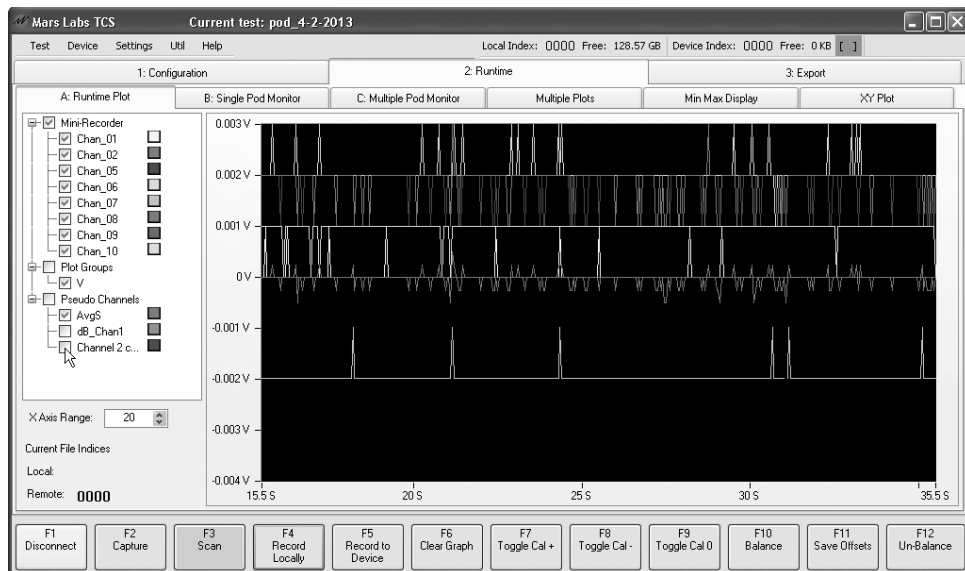

Single Pod Monitor:

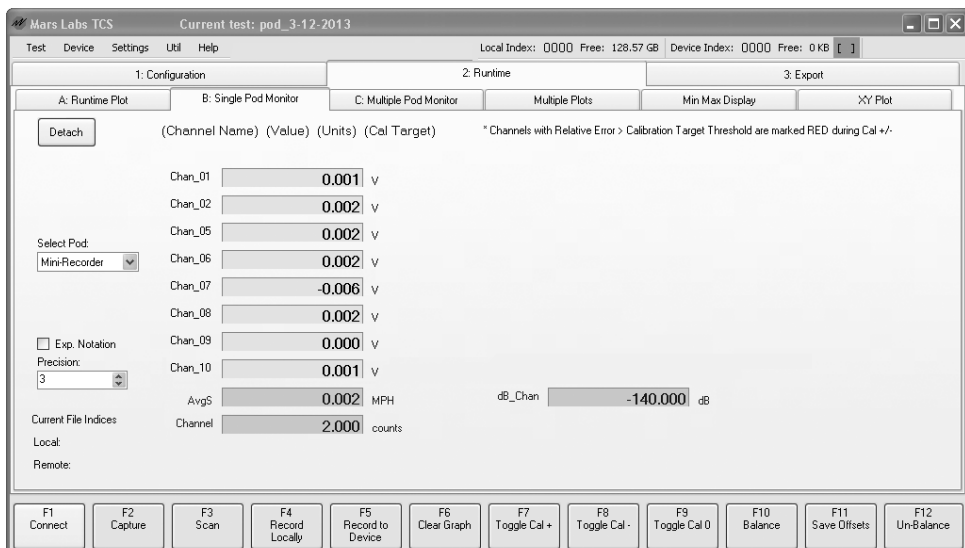

Multiple Pod Monitor:

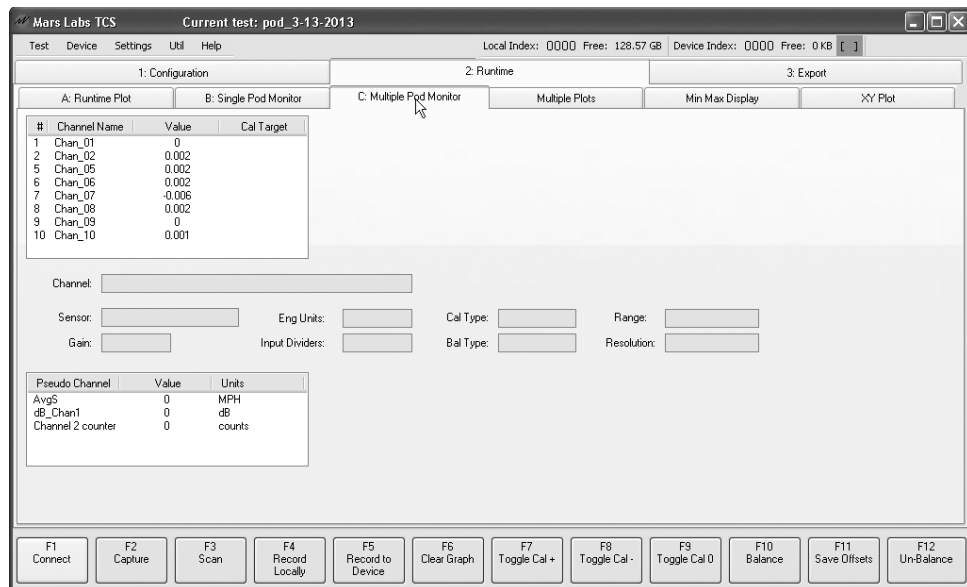

The Digital Data tab display of the InVehicle screen:

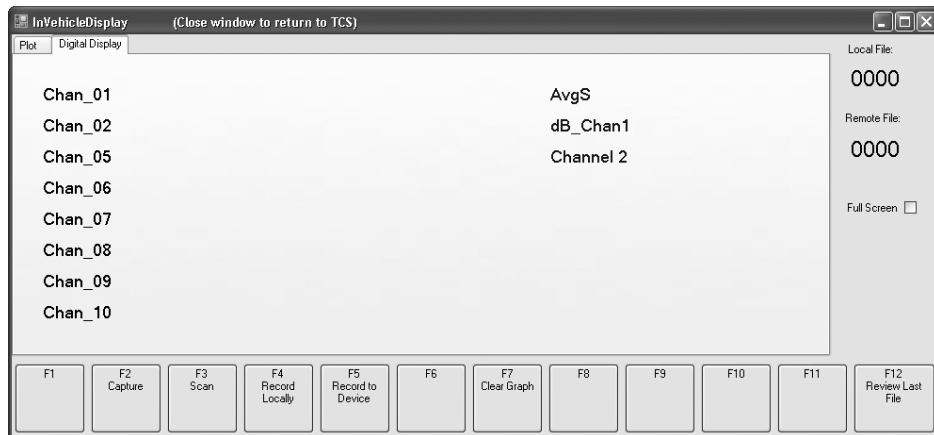
**NOTES:**

1. If a value cannot be displayed, it will appear as NaN (Not a Number) in all digital display screens. It will be ignored on the runtime plot.
2. Due to space limitations on some screens, pseudo channel names may be truncated.
3. Due to restricted window space, the Single Pod Monitor and In-Vehicle screens can display a maximum of eight pseudo channels. If more than eight pseudo channels are defined, only the first eight will be displayed.
4. When using a CPU with multiple Pods, the Single Pod Monitor screen only displays values from the currently selected Pod. Pseudo channel values, however, are displayed independently and will always appear at the bottom of the display regardless of which Pod is selected.

Recording & Triggers

The *Recording & Triggers* screen is where you configure the Device Trigger parameters of the connected hardware, create user-defined TCS Triggers, schedule the frequency and duration of non-continuous recordings, enable a series test sequences, and configure File Control parameters.

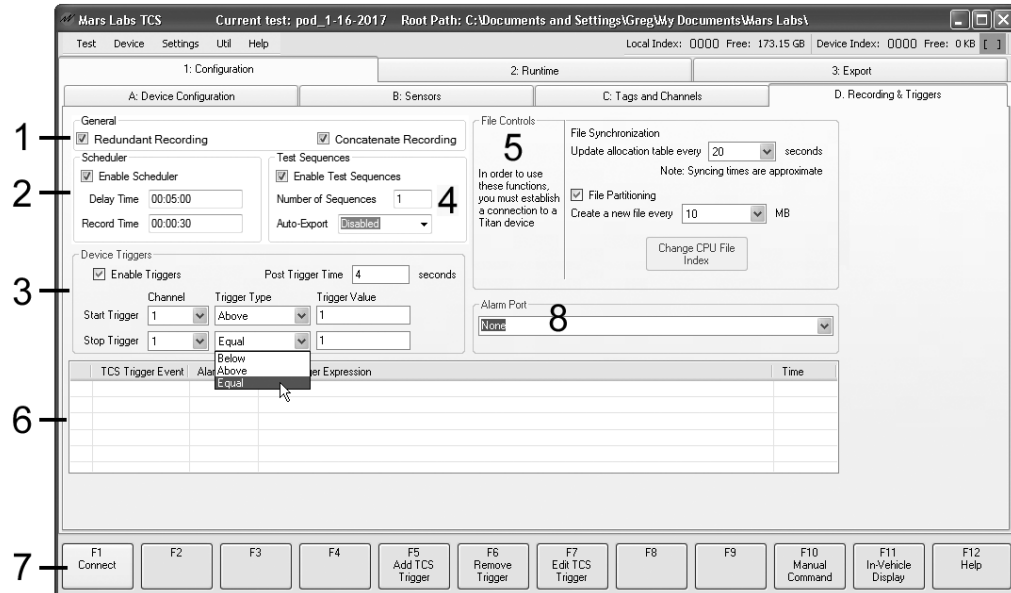

The main components of the *Recording & Triggers* screen are:

1. ‘Redundant Recording’ checkbox - When checked, TCS will always record to both Local and Remote when either recording option is selected, or when Remote recording is activated on the Mini-Recorder or CPU while the device is connected.
- ‘Concatenated Recording’ checkbox - When checked, TCS creates a single TDF file for any number of local recordings made during a single scan session ([F4] Rec ON / Rec OFF). Concatenated Recording will create a new file with each new Scan session ([F3] Scan). The setting is stored with the TCF and TDF files.
2. ‘Scheduler’:
 - a. ‘Enable Schedule’ checkbox – Enables/disables the Schedule function. When enabled, the recording period will start before the delay period i.e. record, then wait.
 - b. ‘Delay Time’ / ‘Record Time’ fields – When the Schedule function is enabled, local recording takes place according to the frequency (Delay Time) and duration (Record Time) parameters specified. Data must be entered in ‘hh:mm:ss’ format for both fields.
3. ‘Device Triggers’:
 - a. ‘Enable Triggers’ checkbox – Enables/disables the Device Triggers.
 - b. ‘Start Trigger’ / ‘Stop Trigger’ – Drop-down menus to select the individual trigger channels.

NOTE: If no SD card is installed, Device Recording options will be ignored

- c. 'Post Trigger Time' field – Specifies the recording time interval after the Stop Trigger is received:

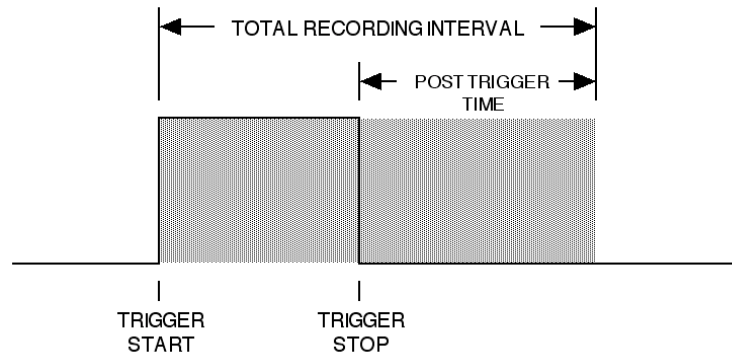

- d. 'Trigger Value' field – Specifies the trigger threshold in counts.
- e. 'Trigger Type' – Drop-down menus to select the trigger modes for the Start and Stop Triggers:

'Above' – Recording starts when the input goes above the trigger value.
 'Below' – Recording starts when the input goes below the trigger value.
 'Equal' – Recording starts when the input is equal to the trigger value.

4. 'Test Sequences':

'Enable Test Sequences' - Enables/disables the Test Sequence option. When enabled, each newly recorded file is counted as a sequence in the Local File Indices on the Runtime screen. The number of sequences for each test is specified by entering a value in the 'Number of Sequences' text box. Test Sequence files are recorded with dash number suffixes indicating the test subsequence. For example, if the 'Number of Sequences' is set to '3', the recorded test files will appear as:

```
Pod_test_1_0001-01.tdf
Pod_test_1_0001-02.tdf
Pod_test_1_0001-03.tdf
Pod_test_1_0002-01.tdf
etc.
```

If an export option is selected from the Auto-Export drop-down, an HDF5 file (normal or high precision) will be created for each subsequence and stored in the current tests' Export folder.

5. 'File Controls': Configures File Synchronization and File Partitioning parameters (see File Controls, page 102)
6. 'TCS Trigger Event' grid: Displays user-defined TCS Trigger Events (see TCS Triggers, page 104).

7. Function Keys - In the Recording & Triggers screen, the function keys are assigned the following functions:

- [F1] – Connects/disconnects to the device hardware
- [F5] – Adds a TCS Trigger Event
- [F6] – Removes a TCS Trigger Event
- [F7] – Edits a TCS Trigger Event
- [F10] – For issuing Manual Commands to the device hardware
- [F11] – Invokes the In-Vehicle Display
- [F12] - Invokes the embedded TCS User Manual

8. ‘Alarm Port’ - This dropdown selects the port that will be used for the outboard alarm indicator when one or more cables are connected. The Alarm Port works in conjunction with the ‘Alarm Only’ event function configured in TCS Triggers.



File Controls

The File Controls pane allows you to specify the file handling parameters for Mini-Recorder SD memory cards, and reset the CPU Index. This pane will be grayed out until you connect to a Titan Device (Function key [F1] - Connect). Only the options that pertain to the connected device will then appear; other options will remain grayed out.

NOTE: File Synchronization and Partitioning controls appear when connected to a Titan Pod. A Pod has no built-in recording function, so these controls have no effect.

File Synchronization

Applicable only to Titan Mini-Recorders, this parameter sets the time interval for updating the FAT table on the SD memory card, in increments from ten seconds to five minutes:

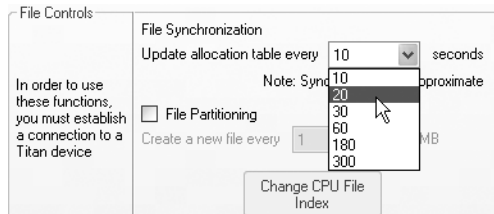

NOTE: Synchronization times in the drop-down list are approximate

File Partitioning

When enabled, this sets the partition size for recorded data. Partitioning breaks up test files into small chunks; when the chunk size limit is reached the file is closed out and stored, and a new file is opened. Partitioning can preserve the integrity of large tests. For example, if a long test is interrupted in the final few seconds before completion, only the last chunk of data may be corrupted or invalid - the partitioned data files taken during the test will remain unaffected.

When file partitioning is disabled, no partition size is set.

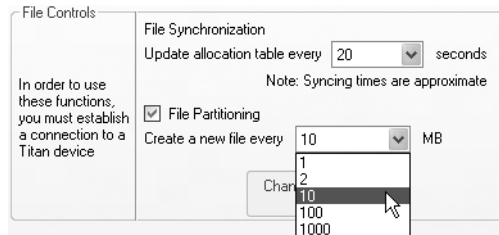

NOTE: When file partitioning is enabled on a Titan Mini-Recorder, the overhead associated with the partitioning operation will result in some lost data. The data loss will be a function of the scan rate. The amount of data loss can vary from approximately 1/3 second to 1 second between partitions, depending on the scan rate.

CPU File Index

Available only when connected to a CPU Channel Expander, the 'Change CPU File Index' button allows you to change the file index value:

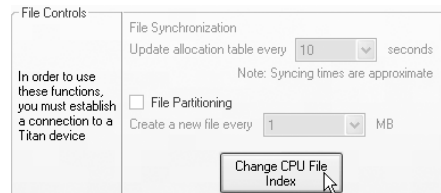

Clicking on the button produces a selection window that allows you to set the index value to any number (0 to 9999). To set the value, use the increment/decrement control or manually enter the value in the number field:

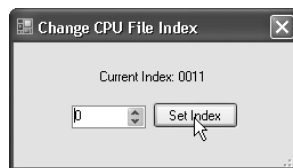

NOTES:

1. If you attempt to enter a number larger than 9999, it will automatically be corrected to '9999' before being sent to the Expander.
2. After resetting the index to '0', TCS will display a "?" in the Device Index field until a new remote recording is made.

TCS Triggers

TCS now includes user-defined TCS Triggering options. TCS Triggering works similarly to the Device Triggers, but with the following differences:

1. There can be any number of triggers for starting and stopping recording. Triggers may contain conditional or logical expressions combined with math operations, similar to the expressions in the Pseudo Channel engine. All triggers of the same type are implicitly combined by a logical OR operation (for convenience), since a single trigger may contain those expressions combined by the logical OR in an explicit manner.
2. TCS Triggers work without an SD card in the device (local recording only).
3. The triggers may serve any number of Titan devices connected to the CPU module.

NOTE: *The processing of TCS Triggers is performed exclusively by TCS for local recording; these triggers do not apply for stand alone (remote) recording. However, if the 'Redundant Recording' option is enabled and the Mini-Recorder has an SD card installed, triggering **will** apply to both local and remote recording.*

Triggers are defined by mathematical expressions using a common syntax with added comparison and logical operators. For example, consider the following expression:

$$\text{abs}(\text{Chan_01}+\text{Chan_02}+\text{Chan_03})/3 \geq 5.5 \ \& \ \text{Chan_04} < 1$$

In this example, 'Chan_01', 'Chan_02', 'Chan_03' and 'Chan_04' are the actual channel names, and 'abs' is the 'absolute value' function. In the first part of the expression, the values of the first three channels are summed and averaged, and then the absolute value is obtained. In the second part of the expression, the value '5.5' is logically ANDed to the value of Channel 4. If the result of the second expression is less than '1', and if the result of the first expression is greater than or equal to the value of the second expression, then the conditions are met for a trigger event to occur.

For Trigger expressions, the available Arithmetic Operators are:

Operator	Definition	Precedence	Association
+	Addition	1	left to right
-	Subtraction	1	left to right
*	Multiplication	2	left to right
/	Division	2	left to right
%	Modulus	2	left to right
^	Power	3	right to left
- (unary minus)	Negation	4	right to left

NOTE: *Unary plus is not supported*

The available Logical and Conditional Operators are:

Operator	Definition	Precedence	Association
&	Logical AND	1	Left to Right
	Logical OR	1	Left to Right
<	Less then	2	None
>	Greater than	2	None
=	Equals to	2	None
<=	Less or Equal	2	None
>=	Greater or Equal	2	None
!=	Not equal	2	None

The expression syntax follows the standard order of mathematical operations. However, the precedence of the logical operators differs from the one in C-like programming languages. The reason for that is convenience. For example, expression such as 'a+b < c*d & sin(b) > 0.5' will be executed in the most natural order:

1. a+b
2. c*d
3. the operator '<'

If true, then:

4. sin(b)
5. the operator '>'
6. the operator '&'

Thus, it is possible to reduce the number of parentheses, keeping logical consistency, although it is always recommended to use parentheses in a reasonable manner for clarity.

The available Functions are:

Function	Argument	Definition
sin(a)	1 (radians)	Sine
cos(a)	1 (radians)	Cosine
tan(a)	1 (radians)	Tangent
deg(a)	1	Convert degrees to radians
rad(a)	1	Convert radians to degrees
asin(a)	1	Arcsine
acos(a)	1	Arccosine
atan(a)	1	Arctangent
atan2(y, x)	2 (y, x)	Corresponds to C/C++ atan2
sinh(a)	1	Hyperbolic sine
cosh(a)	1	Hyperbolic cosine
tanh(a)	1	Hyperbolic tangent
ln(a)	1	Natural logarithm (to base e)
log2(a)	1	Logarithm to base 2
log10(a)	1	Logarithm to base 10
exp(a)	1	Exponential function (e^a)
sqrt(a)	1	Square root
sign(a)	1	-1 if $a < 0$, 0 if $a = 0$, 1 if $a > 0$
abs(a)	1	Absolute value
min(a, b)	2	Minimum value of a and b
max(a, b)	2	Maximum value of a and b
floor(a)	1	Round a value downwards to the nearest integer
ceil(a)	1	Round a value upwards to the nearest integer
round(a, ndigits)	1	Round a value to a specified number of fractional digits (ndigits)
count(a)	1	Increments the counter when the logical expression is true
env_abs(a, rel time)	2	An envelope follower function with zero attack time and a user-specified release time (in seconds). The function simulates a circuit with a rectifier bridge followed by a capacitor and resistor in parallel. Permits tracking the amplitude of an AC signal over time.
env_rms(value, time)	2	Produces the average (root mean square) within the specified time window (in seconds).
lpf1(value, cutoff)	2	A first order (-6dB/oct) low pass filter. The cutoff frequency is specified in Hertz.
hpf1(value, cutoff)	2	A first order (-6dB/oct) high pass filter. The cutoff frequency is specified in Hertz.

The functions ‘floor’, ‘ceil’, and ‘round’ can be useful when using the ‘=’ operator. The nature of the binary representation of floating point numbers is that one must be very careful when comparing the numbers for strict equality. For example $0.2 * 0.1$ is not equal to $0.2/10$, because there are simply no such numbers as 0.1 and 0.2 in computers; they cannot be represented exactly (a similar fact is there is no number $1/3$ in the decimal-point form). Rounding the values to 4 decimal digits, for example, may help avoid potential problems.

The available Constants are:

Constant	Value
E	2.71828182845904523536
PI	3.14159265358979323846
SQRT2	1.41421356237309504880
LOG2E	1.44269504088896340736
LOG10E	0.434294481903251827651
LN2	0.693147180559945309417
LN10	2.30258509299404568402

Numerical values also have common syntax in decimal-point or exponential form. For example:

23
1.5543
6.626068E-34.

Channel data values are identified by using the actual channel names. For example:

“Chan_01”
“1_Ch_2”
“Right_wheel_accel”
“Engine_temperature_sensor”

It is important to understand that the expression parser must be able to distinguish between the numeric values, channel names, and reserved words for function and constants; channel names such as “123” or “sin” are thus incorrect and cannot be used in pseudo channel expressions. In other words, channel names cannot be parseable numbers or reserved keywords.

Creating Triggers

Triggers are created in the ‘Recording & Triggers’ screen. To create a trigger, press [F5] (‘Add TCS Trigger’). This will produce a window as shown below allowing you to create a trigger by defining a trigger expression, selecting a trigger event, specifying a time parameter, and selecting an alarm indicator. To assist in the expression definition process, the window also displays the available operators, functions, and constants, along with an example of the expression syntax:

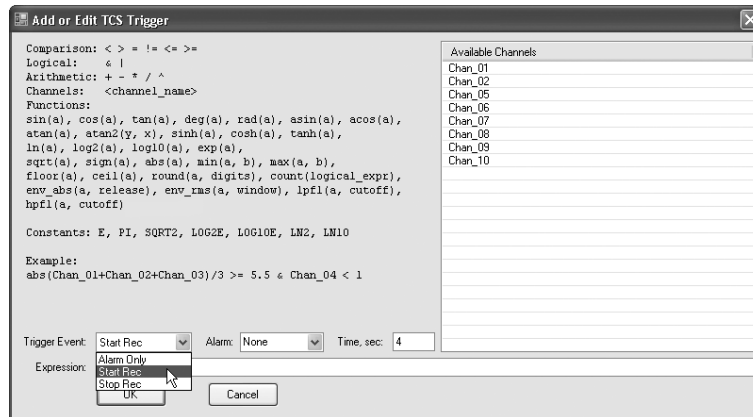

‘Trigger Event’ parameters are selected from a dropdown menu. The selections are ‘Start Rec’, ‘Stop Rec’, or ‘Alarm Only’.

The ‘Time’ parameter has different meaning depending on the type of the selected Trigger Event:

For ‘Stop Rec’ events, it specifies the post-trigger time to continue recording after the event occurred.

For ‘Start Rec’ events, the Time parameter is not currently implemented.

For ‘Alarm Only’ events, the Time parameter is not currently implemented.

NOTE: Since there can be more than one Start and Stop recording trigger, TCS takes into account only the maximal value of the time among all triggers of the same type.

The alarm indicator is selected from the ‘Alarm’ dropdown menu. The indicator is functional only when an ‘Alarm Only’ event is set. Selections are:

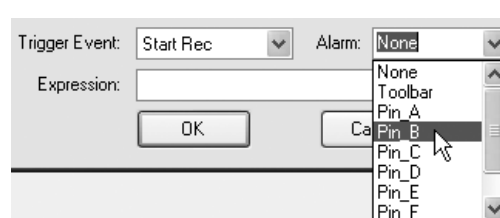

‘None’ - No indicator selected

‘Toolbar’ - Selects the alarm indicator that appears in the upper right of the toolbar.

‘Pins A-H’ - For use with an FTDI type C232HM-DDHSL-0 serial cable or Titan device with a GPIO interface. Selects the pin that will go to a logic ‘1’ state when an alarm event is triggered.

In the 'Expression' field, enter the desired trigger expression. To select channels, double-click on the list of available channel names, or enter the channel name manually. Note that channels that are not enabled in the 'Tags and Channels' screen will not appear in the list. Mathematical operators, functions, and /or constants must be entered manually. You do not have to leave spaces between operators and/or functions in the expression, but you may find that it aids in clarity. If the expression contains an error, a message screen will appear when you press 'OK', alerting you to the nature of the error; if a channel name is entered incorrectly, however, no error message will be displayed.

NOTE: If a channel name is entered incorrectly, TCS will display an error message when you start a scan. To eliminate potential errors in channel names, always select channels from the channel name list instead of manual entry.

Each new trigger definition will be added to the grid at the bottom of the Recording & Triggers screen. Trigger information will appear as it was entered:

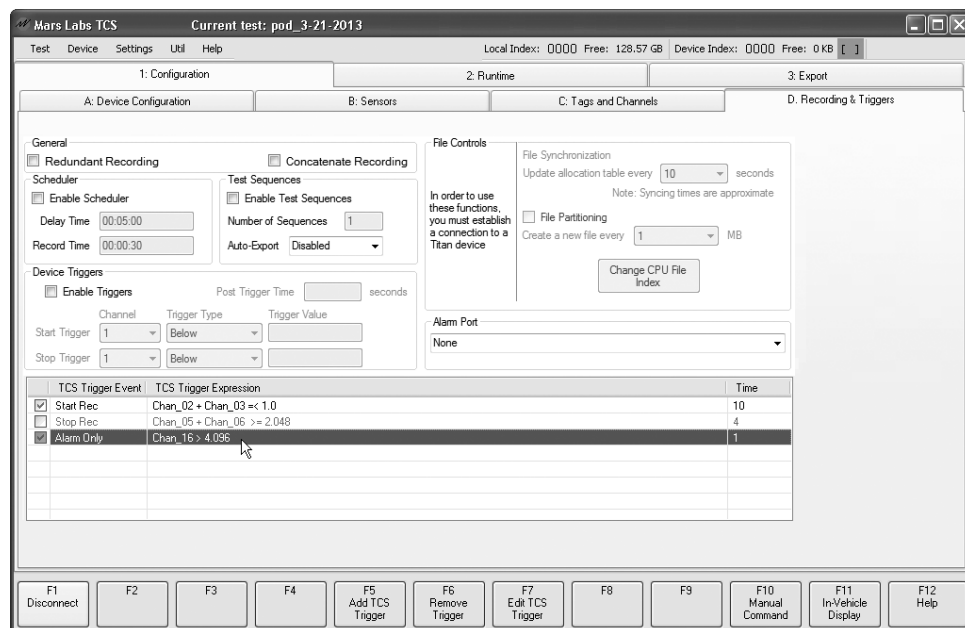

To remove a Trigger, select the desired trigger in the grid and click 'Remove Trigger' [F6]. To edit a Trigger, double-click on the selected channel, or click 'Edit TCS Trigger' [F7]. Triggers are enabled or disabled by clicking in the associated checkbox on the left side of the grid.

NOTE: After defining all Triggers, it's recommended that you save the test prior to running.

For more information on TCS Alarm Triggers, refer to Applications Note APN-1009 - TCS Alarm Trigger Configuration

Runtime Tab

The 'Runtime' tab provides a series of related screens that allows you to view and record sensor data. Individually tabbed windows are provided for each of these functions:



NOTE: The GPS and DIGITAL POD DISPLAY display tabs will only appear in the Runtime screen when the 'GPS' and 'DIGITAL POD' checkboxes are checked and configured on the Device Configuration page. If either box is unchecked, the associated display tab(s) will not appear.

Runtime Plot

The *Runtime Plot* screen allows you view sensor data graphically in a continuous scrolling window. Any channel or groups of channels can be displayed, and the X-axis can be lengthened or shortened as necessary.

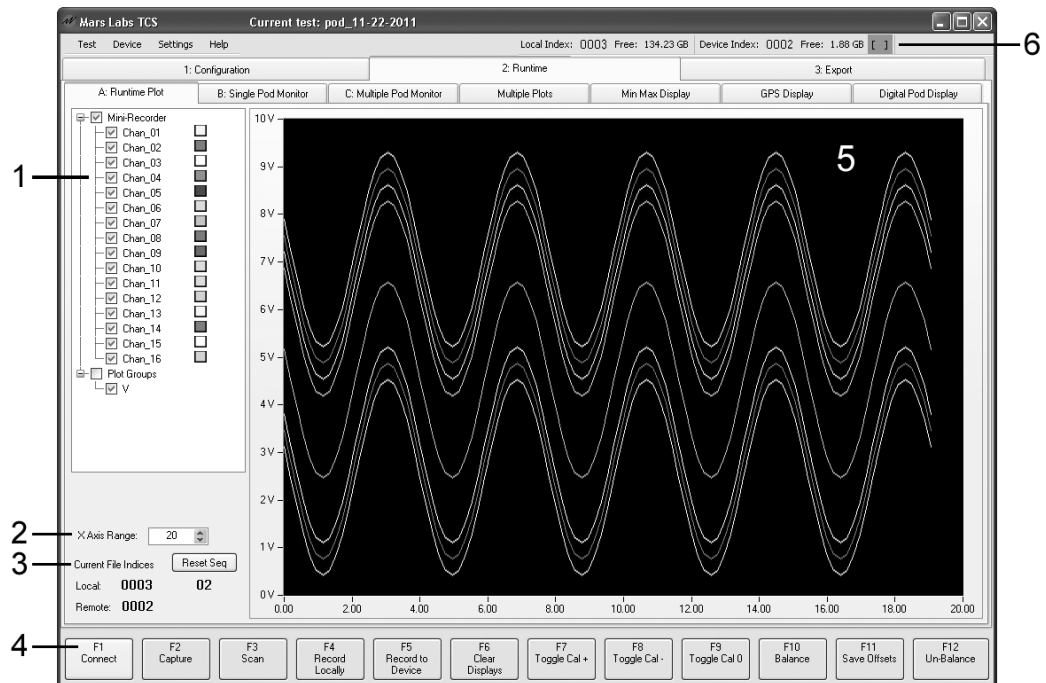

The main components of the *Runtime Plot* screen include:

1. Channel Tree – The Channel Tree allows you to select which channels will be displayed on the plot. Specific channel groupings can also be selected here (for more information, see 'Plot Groups' below). Additionally, channel color codes can be freely reassigned by right-clicking on a channel and selecting from a color palette.

Runtime Plot screen components (cont.):

NOTE: To appear in the Channel Tree list, a channel must be enabled in the Tags and Channels screen.

2. X-Axis Range – Allows you to select the display interval of the X-axis, from as short as 1 second to 3600 seconds (1 hour). The default interval of 20 seconds provides a continuous 20-second scrolling display.

NOTE: There are several Runtime Plot options available. You access these in the SETTINGS menu, under 'Plot Options'

3. 'Current File Indices' – This field displays the current data file indices for locally-recorded and remotely-recorded tests. If 'Test Sequences' is enabled (on the Tags & Channels screen), a sequence number and a Reset button is also displayed. For the example shown, 3 tests were recorded locally with two test sequences, and 2 tests were recorded remotely.
4. Function keys – In the Runtime window, the Function keys are assigned the following functions:
 - [F1] - Connects/disconnects to the selected Titan device
 - [F2] - Selects the Capture function
 - [F3] - Initiates data scanning
 - [F4] - Initiates Local recording (records to the PC)
 - [F5] - Initiates Remote recording (records to the device). If the connected Titan device does not support remote recording, this button has no function
 - [F6] - Clears the plot widow
 - [F7] - Toggles the 'Cal+' function
 - [F8] - Toggles the 'Cal-' function
 - [F9] - Toggles the 'Cal 0' function
 - [F10] - Selects the Balance function. Balance will be applied to all channels that have Balance enabled in the Tags and Channels screen (Bal Type = YES). For more on the operation of the Balance function, see page 91.
 - [F11] - Saves the channel offsets for all channels to the connected Titan device. Channels that have Balance disabled in the Tags and Channels screen will get an offset value of '0' (no offset).
 - [F12] - Restores channel offsets
5. Plot Window - A scrolling view of selected data channels
6. Alarm Indicator - Illuminates when an input signal exceeds the alarm threshold set in TCS Triggers and when the Alarm Indicator is set to 'Toolbar'.

The Capture Function

The Capture function allows you to acquire and display a pre-defined amount of sensor data from a single channel.

When you press 'Capture' [F2], a dedicated capture window appears. Within the window are fields to select the channel and the amount of data to acquire in seconds.

Each time you press the 'Re-acquire Data' button, TCS will capture and display the data from the selected channel.

NOTES:

1. The maximum amount of data that can be acquired is 1.2M samples.
2. For a two-minute acquisition of 16 channels at 10k s/s, a minimum of 4GB of memory is required.
3. Multiple instances of the Capture function can be created by repeatedly pressing [F2]

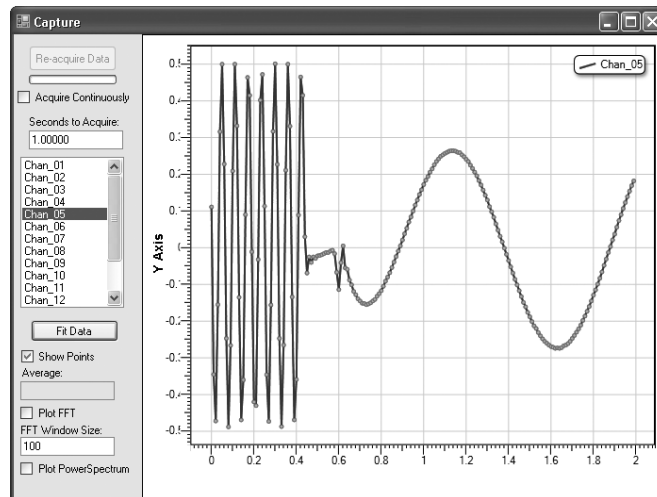

'Acquire Continuously' - Continuously re-acquires and displays the data at the 'Seconds to Acquire' interval

'Show Points' - Toggles the sample points ON/OFF

Average - Displays the average value of all data points in Eng Units

'Plot FFT' - Replaces the XY plot with an FFT of the sampled data

FFT Window Size - Sets the size of the FFT window

'Plot Power Spectrum' - Replaces the XY plot with a Power Spectrum plot

NOTE: The 'Plot FFT' and 'Plot Power Spectrum' checkboxes operate like radio buttons - only one box can be selected at a time.

Additional options in the Capture screen are accessed by right-clicking in the plot window:

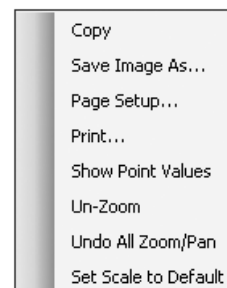

The Plot Groups Function

The Plot Groups function appears at the bottom of the Channel Tree. ‘Plot Groups’ allows you to conveniently group and display related sensor types.

To illustrate how the Plot Groups function works, suppose you have a 16-channel Titan device where channels 1, 3 and 5 are connected to Strain Gauges and all other channels are connected to Voltage sensors. The Plot Groups function allows you to display the like-sensor types by selecting the engineering value that represents these sensors. To illustrate how this works, refer to the examples below. The example on the left shows that when the micro-strain value (μE) is selected in ‘Plot Groups’ only those channels with Strain Gauge sensors connected will be charted on the plot; voltage channels will be excluded.

The example on the right shows the reverse condition - when the voltage value (V) is selected, only those channels with Voltage sensors connected will be charted on the plot; channels assigned to Strain Gauge sensors will be excluded.

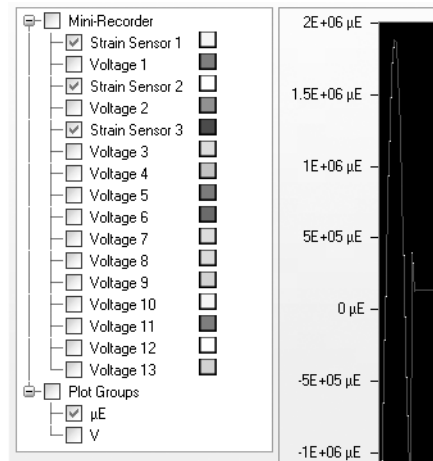

Selecting the Strain Gauge sensor groups using the Plot Groups function

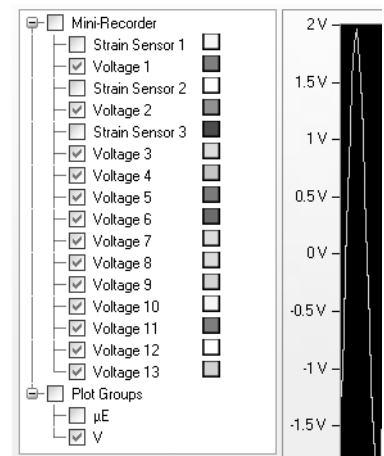

Selecting the Voltage sensor groups using the Plot Groups function

NOTE: The Plot Groups function is not available for CPU test configurations.

Single Pod Monitor

The ‘Single Pod Monitor’ screen allows you view numerical sensor data for a single Pod or Mini-Recorder. The screen will only display channels that are enabled in the Tags and Channels window. If Pseudo Channels are also defined, these channels will appear at the bottom of the display.



The main features of the Single Pod Monitor screen include:

1. Detach button – The Detach button opens a separate ‘Digital Monitors’ window containing the numerical data. This allows you to view the graphical and numerical data simultaneously.
2. Numerical Display fields – Each data field is identified by the name assigned in Tags and Channels screen.
3. ‘Select Pod’ - This drop-down allows you to select the desired Pod or Mini-Recorder when more than one Titan device is connected.
4. ‘Exp Notation’ checkbox – When this box is checked, the data is displayed in exponential notation.
5. Precision – This drop-down allows you to select from 0 to 7 values of precision in the displayed data.
6. ‘Current File Indices’ – Displays the current data file indices for locally -recorded and remotely-recorded tests. The example above shows that 3 tests have been recorded locally.

Multiple Pod Monitor

The 'Multiple Pod Monitor' screen displays the numerical sensor data from multiple Pods or Mini-Recorders, along with the Min/Max values for each channel. If Pseudo Channels are also defined, these channels appear at the bottom left of the display.

The screenshot shows the 'Multiple Pod Monitor' screen in the Mars Labs TCS software. The interface is divided into three main sections: 1. Configuration, 2. Runtime, and 3. Export. Under the 'Runtime' section, there are sub-sections for 'A: Runtime Plot', 'B: Single Pod Monitor', and 'C: Multiple Pod Monitor'. The 'Multiple Pod Monitor' section displays a table with 16 channels, each with a 'Value' and 'Min/Max' column. The 'Min/Max' column is highlighted in green for all channels, indicating that the values are less than 70% of the peak value. Below the table, there are controls for the selected channel (Pod1_Ch07), including sensor type, gain, input dividers, and calibration type. A 'Pseudo Channel' table is also visible at the bottom left of the main display area.

#	Channel Name	Value	Min/Max
1	Pod1_Ch01	-0.0020	0.00 / 0.00
2	Pod1_Ch02	0.0070	0.01 / 0.01
3	Pod1_Ch03	-0.0010	0.00 / 0.00
4	Pod1_Ch04	0.0090	0.01 / 0.01
5	Pod1_Ch05	0.0000	0.00 / 0.00
6	Pod1_Ch06	0.0080	0.01 / 0.01
7	Pod1_Ch07	-0.0080	-0.01 / -0.01
8	Pod1_Ch08	0.0050	0.00 / 0.01
9	Pod1_Ch09	0.0000	0.00 / 0.00
10	Pod1_Ch10	0.0030	0.00 / 0.00
11	Pod1_Ch11	0.0000	0.00 / 0.00
12	Pod1_Ch12	0.0030	0.00 / 0.00
13	Pod1_Ch13	-0.0010	0.00 / 0.00
14	Pod1_Ch14	0.0040	0.00 / 0.00
15	Pod1_Ch15	-0.0020	0.00 / 0.00
16	Pod1_Ch16	0.0040	0.00 / 0.01

The Min/Max values are displayed in green when the value is less than 70% of the peak value, yellow if the value is between 70% and 98% of the peak, and red if the value is 98% or above.

When Toggle CAL is activated (F7, F8 or F9), the Min/Max column switches to show the calibration target values. The Cal Target value appears in green when the channel is in cal, and appears in red if the channel is out of cal.

The screenshot shows the 'Multiple Pod Monitor' screen in the Mars Labs TCS software, with the 'Toggle CAL' function activated. The 'Multiple Pod Monitor' section displays a table with 16 channels, each with a 'Value' and 'Cal Target' column. The 'Cal Target' column is highlighted in green for all channels, indicating that the channels are in calibration. Below the table, there are controls for the selected channel (Pod1_Ch07), including sensor type, gain, input dividers, and calibration type. A 'Pseudo Channel' table is also visible at the bottom left of the main display area.

#	Channel Name	Value	Cal Target
1	Pod1_Ch01	16.3520	16.3830
2	Pod1_Ch02	16.3610	16.3830
3	Pod1_Ch03	16.3530	16.3830
4	Pod1_Ch04	16.3670	16.3830
5	Pod1_Ch05	16.3550	16.3830
6	Pod1_Ch06	16.3550	16.3830
7	Pod1_Ch07	16.3440	16.3830
8	Pod1_Ch08	16.3630	16.3830
9	Pod1_Ch09	16.3530	16.3830
10	Pod1_Ch10	16.3610	16.3830
11	Pod1_Ch11	16.3530	16.3830
12	Pod1_Ch12	16.3610	16.3830
13	Pod1_Ch13	16.3560	16.3830
14	Pod1_Ch14	16.3610	16.3830
15	Pod1_Ch15	16.3540	16.3830
16	Pod1_Ch16	16.3620	16.3830

Multiple Plots

The ‘Multiple Plots’ screen allows you view sensor data on selected channels:

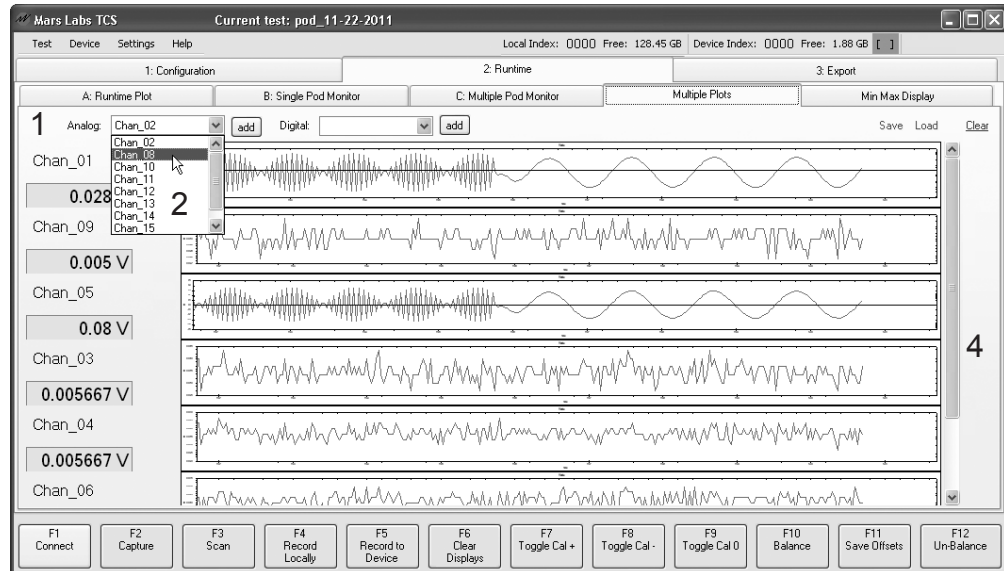

The main features of the Multiple Plots screen include:

1. Add Channels – Selects specific analog and/or digital channels to display in the plot window. After making a selection, click on the ‘ADD’ button. As channels are added, the plots will automatically be resized to fit into the window.
2. Channel selection drop-down
3. ‘Clear’ button – A button that removes all plots from the display.
4. Scroll bar – The scroll bar appears when more than five plots are displayed at one time in an unexpanded window.

NOTE: The ‘Multiple Plots’ screen will allow you to view up to ten channels maximum, regardless of the size of the viewing window.

Min Max Display

The ‘Min Max Display’ screen allows you track the maximum, minimum, and average values of each enabled channel. The min and max values that are displayed here are also displayed on the Multiple Pod Monitor screen.

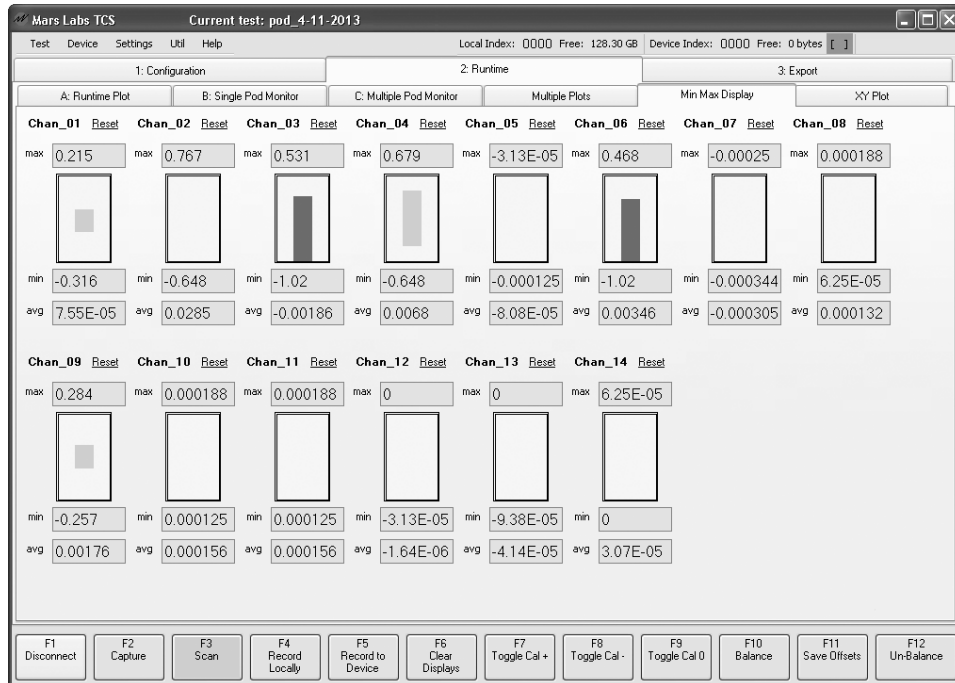

To reset individual channels, click on the associated ‘Reset’ channel label. To reset all values, click “Clear Displays” [F6].

The bar charts display channel values in green when the value is less than 70% of the peak value, yellow if the value is between 70% and 98% of the peak, and red if the value is 98% or above.

NOTE: The MinMax display will only show the first 16 enabled channels. When using a CPU with multiple Pods connected, only the first 16 enabled channels will be displayed, starting with the Pod at Port 1, then Port 2, etc.

XY Plots

Described on page 22.

GPS Display

The 'GPS Display' screen allows you view the GPS data. A 'Detach' button places the GPS data into a separate, movable window, allowing you to view both the GPS and the plotted or numerical data at the same time.

NOTE: When you click on the 'Detach' button, it opens a separate GPS Display window, and the button label changes to 'Reattach'. When you click on 'Reattach', the GPS Display window closes and the data in that window reappears under the 'GPS Display' tab.

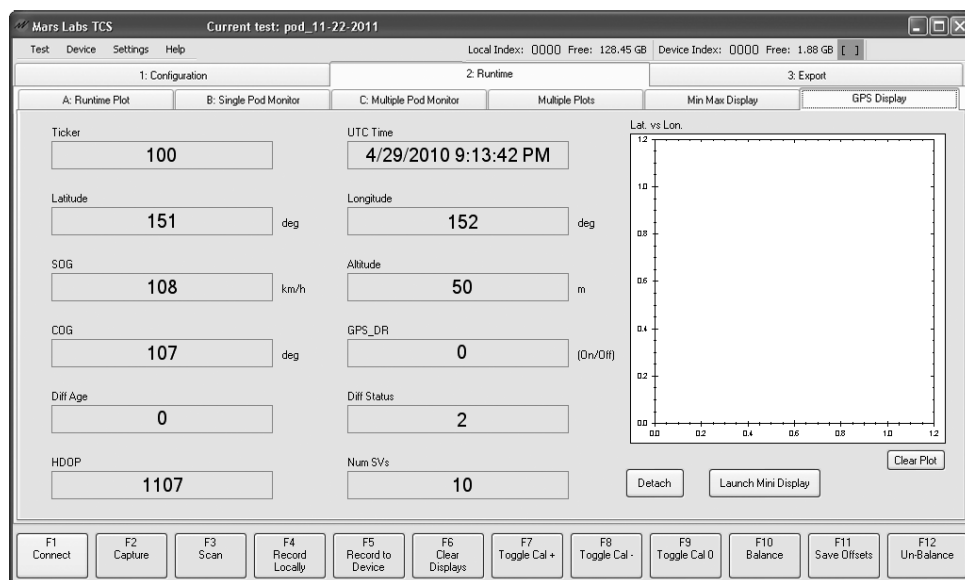

GPS field definitions:

Ticker – The scan count when recording. Used to match which scan the GPS message belongs to.

UTC Time – Coordinated Universal Time, displayed as:
MM/DD/YYYY HH/MM/SS AM/PM

Latitude – Latitude hemisphere (N or S), measured in degrees

Longitude – Longitude hemisphere (E or W), measured in degrees

Altitude – Height above mean sea level, measured in meters.

SOG – Speed Over Ground in Kilometers per hour (kph). The SOG value is multiplied by 10 to remove the decimal component.

COG – ‘Course Over Ground’ in degrees. The COG value is multiplied by 100 to eliminate decimal points.

GPS_DR – GPS Dead Reckoning. Not implemented.

NUM SV’s – Number of Satellites Visible

HDOP – Horizontal Dilution Of Precision. The HDOP value is multiplied by 100 to eliminate the decimal point. Values range from 500 to 9990.

DIFF AGE – Not implemented.

DIFF STATUS – GPS lock status. Values:

0: No lock

1: Non-differential GPS lock

2: Differential GPS lock

6: Estimated lock

Digital Pod Display

Described on page 23.

IMU Display

Described on page 24.

WFT Plot/WFT Display

Described on page 25.

Export Tab

The 'Export' tab provides two related screens that allow you to review and export locally and remotely recorded data sets.

Export and Review Tab

The 'Export and Review' screen allows you to view all of the locally recorded data sets created under the current test name, as well as previously recorded data sets acquired under other test names.

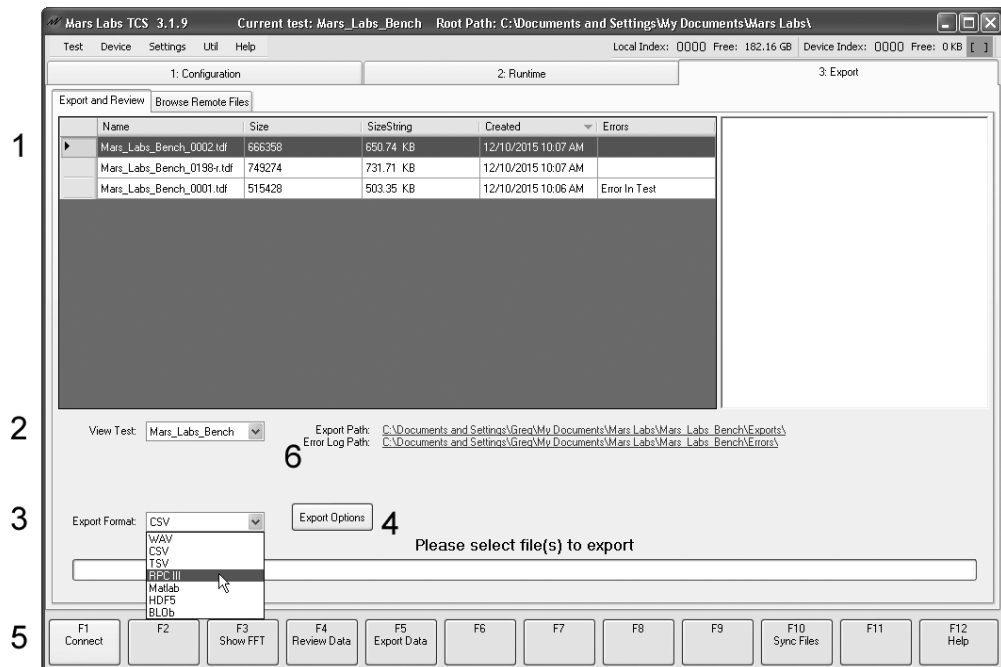

The main components of the Export and Review screen include:

1. Data set list – A list of all of the data sets recorded under the current test name.
2. 'View Test' – A drop-down menu that allows you to view data acquired from different tests.
3. 'Export Format' - A drop-down menu to select the desired export format (pg 32).
4. 'Export Options' – Presents a window of Export Options for various export formats (pg 33).

5. Function keys – In the Export and Review window, the Function keys are assigned the following functions:

- [F1] - Connects/disconnects to the selected Titan device
- [F3] - Displays the FFT Review window (pg 27)
- [F4] - Displays the Multi-Plot review window (see below)
- [F5] - Exports the selected data set according to the selected channels, export format, and GPS status. See Supported Data Types (pg33)
- [F10] - Synchronizes multiple GPS Pulse Per Second (PPS) files
- [F12] - Invokes the embedded TCS User Manual

6. Export Path – Displays the current export path.
Error Log Path – Displays the current error log path.

Export and Error Log path hyperlinks will be blank until a file is exported, or until an existing test is selected in the ‘View Test’ dropdown. Once a file is exported (or an existing test selected), hyperlinks will appear. Clicking on either link will take you to the respective file location.

Error Logs

TCS reads, displays, and records test error information from connected CPU or CPX devices (requires firmware v2.2 or later to be installed). Errors are reported in the ‘Errors’ column on the ‘Export and Review’ and ‘Browse Remote Device’ screens.

The ‘Errors’ column displays one of three error conditions. If the field is blank, it means that no configuration or connection errors were detected. If ‘Error in Test’ is displayed, at least one error was detected that resulted in a potential loss of data or no data. If ‘Not Supported’ is displayed, then the connected device(s) do not support error reporting.

Error Logging

Devices that support error reporting will create a separate error log for each test. Error log file names include the test name, the test index value, and the test error extension ‘tef’:

[testname]_[index value].tef

When multiple CPUs are connected to a CPX Expander in large channel-count systems, individual CPU error log files will include the IP Address of the device:

[testname]_[index value]_[IP Address].tef

Error log files are transferred to TCS when the remote data files are transferred (see Transfer Files, pg 125). Error logs are stored in the Error Directory (see next page). Once transferred, error logs can be viewed using WordPad or a similar text reader. If no errors were detected, the error log will be empty (0 bytes). If an error is detected, the error log will contain an error message.

The Error Directory

When a new test configuration is saved (or the first time a scan is initiated), TCS creates an Error directory under the current test file directory. TCS will generate an error log file labeled [testname].tef when downloading a test configuration at the start of a scan. This file contains a list of test configuration commands and acknowledgements, along with any issues that were encountered during the download. Note that this file always contains the current test configuration. If the test configuration changes, this file will be overwritten when a new scan is initiated.

If an error is detected during a test configuration download, TCS will write the download information to the error log before timing out. TCS will then display an error message (the example shown here is for a CPU system with two Pods connected, one of which has a problem)



The error message displays the most recent error TCS encountered (“unsupported scan rate”).

Viewing the error log in WordPad reveals that the Pod on port 2 is not responding to earlier commands, as indicated by the lack of acknowledgements as TCS first attempted to configure the device on port 2 for Low Speed operation (“SET_SYSTEM_MODE 0”):

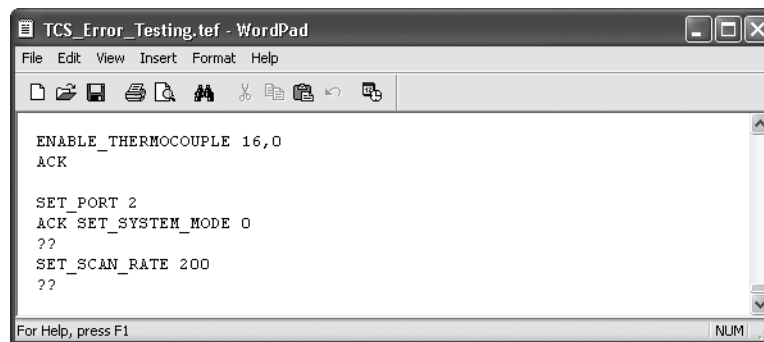

This is an indication of a hardware failure somewhere in the system. In this case, a physical inspection identified that the connection between the Pod on port 2 and the CPU was faulty and needed to be replaced.

Initially populated with just the TCS configuration file, the Error directory is populated as data files are transferred from the connected Titan device (see 'Browse Remote Files, page 125). The example below shows the contents of the Error directory for a large channel-count test system (a CPX Expander plus two CPUs) where errors were detected on CPU#1: If an error log is empty (0 bytes), it indicates that configuration and/or connection errors were not detected.

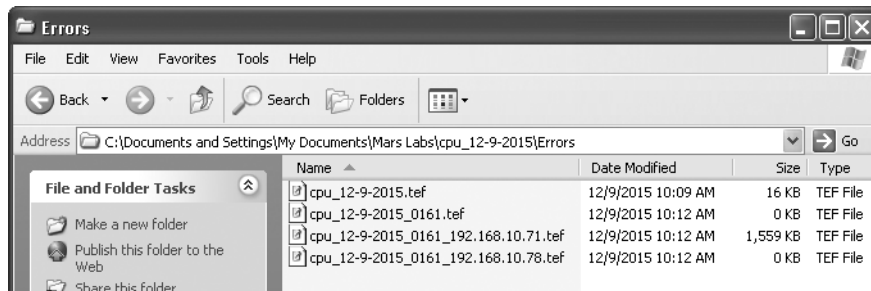

Error Log Identification:
 < TCS configuration file
 < CPX Expander error log
 < 1st CPU error log
 < 2nd CPU error log

Viewing the error log for CPU#1 in WordPad reveals a problem detected with the device on port 2:

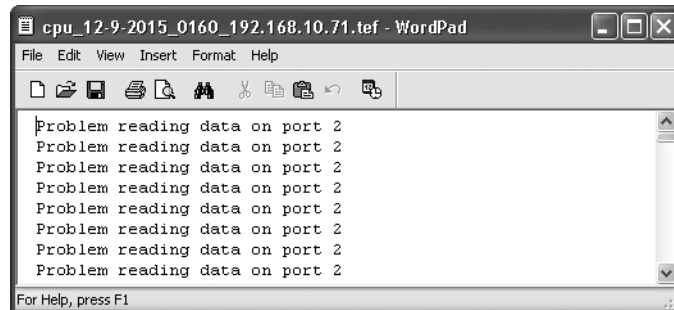

By identifying specific system devices or problem areas, Error Log information can be used to quickly troubleshoot and resolve Titan system issues.

Multi-Plot Review Window

Any test file can be reviewed prior to export using the ‘Review Data’ button [F4] or by double-clicking on the data file. This action brings up a Multi-Plot window that provides a thumbnail display of the complete test record at the top of the window and an expansive area below to display plots of selected data unit groups. Both analog and digital data types are supported (note that J1939 data can have many selectable sublevel units). Displays are enabled by checking the appropriate box in the data unit tree on the left:

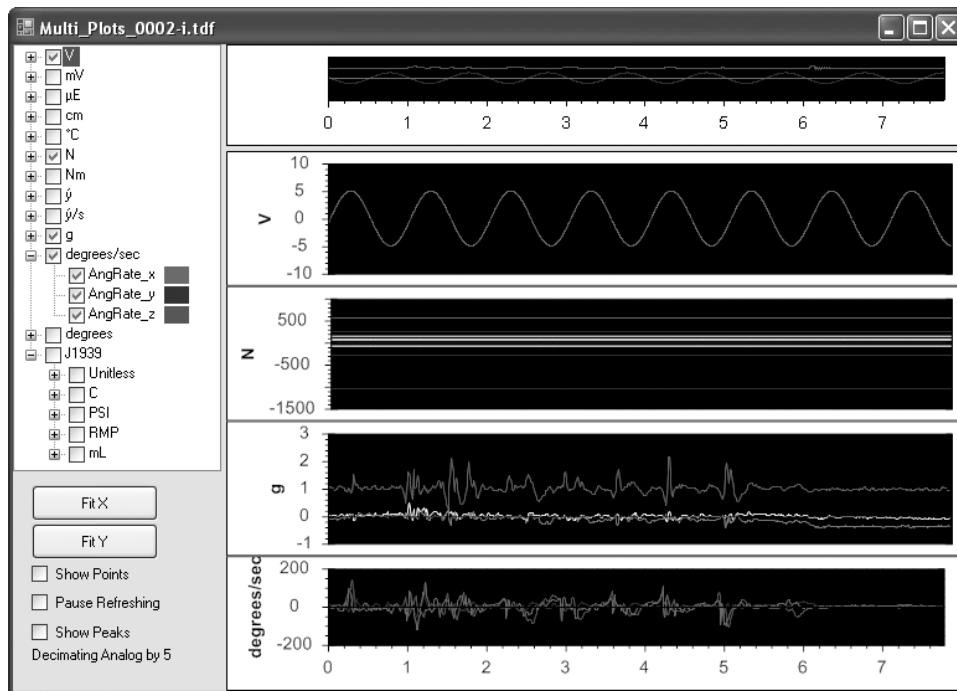

Plots are automatically resized to fit in the available space. Dragging across a portion of the data in any plot (AKA “Box Selection”) produces a magnified view of all plots. Holding down the CTRL key in a magnified view allows you to pan left or right, or up or down, and the mouse scrolling wheel can be used to zoom in or out. The ‘Show Points’ button will toggle the sample points on and off. Enabling the ‘Show Peaks’ button displays an average of the missing peak values when the data is decimated. The ‘Pause Refreshing’ button holds off the screen refresh to allow TCS to process the data on large files without slowing things down. Clicking on the ‘Fit X’ and ‘Fit Y’ buttons will fit the data into the respective axis, useful for quickly returning to a complete view of the entire data file.

Browse Remote Files Tab

The 'Browse Remote Files' screen allows you to access files stored on the connected Titan device or files stored at another location, and transfer the files into TCS:

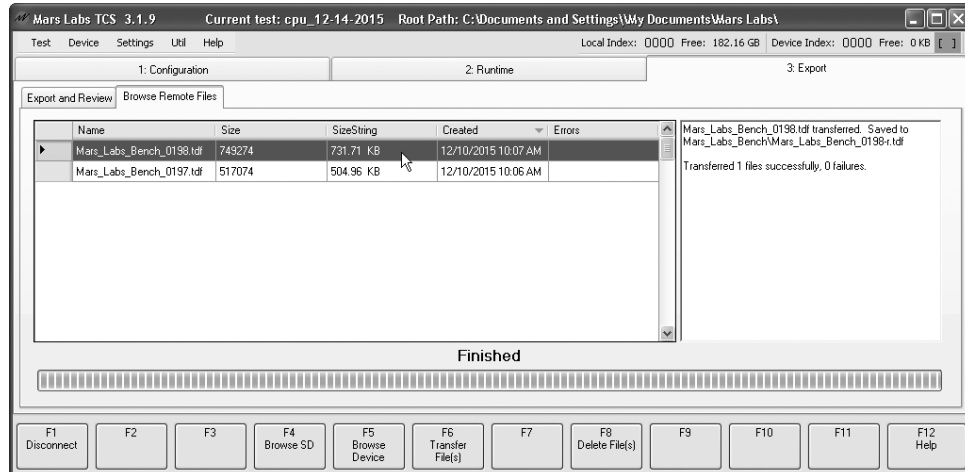

To view files located on the Titan device, click on the 'Browse Device' button [F5]. All recorded test files will be displayed. To transfer the file for viewing in TCS, select a file and then click on 'Transfer Files' [F6], or simply double-click on the file name. The file will be transferred and a status message will be displayed in the status pane on the right. The newly transferred file will appear in the 'Export and Review' screen.

To access Titan files from a different location, click 'Browse SD' [F4]. A 'Browse for Folder' window will appear. You will need to navigate to the directory where the data files are stored:

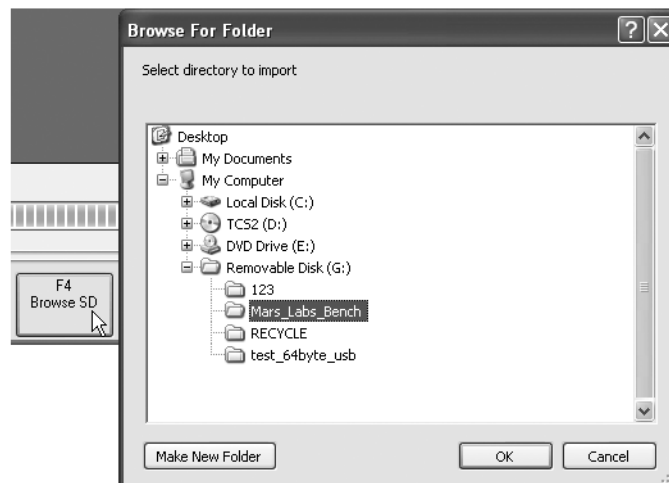

After selecting the desired file, clicking the 'OK' button will transfer the files into TCS.

NOTES:

1. Test files that are recorded remotely have a '-r' or '-e' appended to the file name:

Sample_Test_0002-r.tdf
Sample_Test_0002-e.tdf

2. Test files that are imported from alternate locations will have an '-i' appended to the file name:

Imported_Test_003-i.tdf

TCS File Definitions

The TCS application creates four types of test files: config (configuration) files, data files, error files, and export files.

Config files contain the setup information of each test, including device configuration, sensors, tag and channel assignments, and recording options. Config files have a ‘.tcf’ (TCS Configuration File) extension.

Data files contain the raw recorded data. A new data file is created every time you start and stop the recording process. Data files have a ‘.tdf’ (TCS Data File) extension.

Error files contain any error messages that are reported for a given acquisition. Error files have a ‘.tef’ (TCS Error File) extension.

Export files are the raw data files converted to common file formats (.wav, .csv, .tsv, etc.). Export file formats are selected in the ‘Export Options’ menu in the Export window.

TCS structures all test files by the test name in the default root path:

‘C:\...\My Documents\MarsLabs\

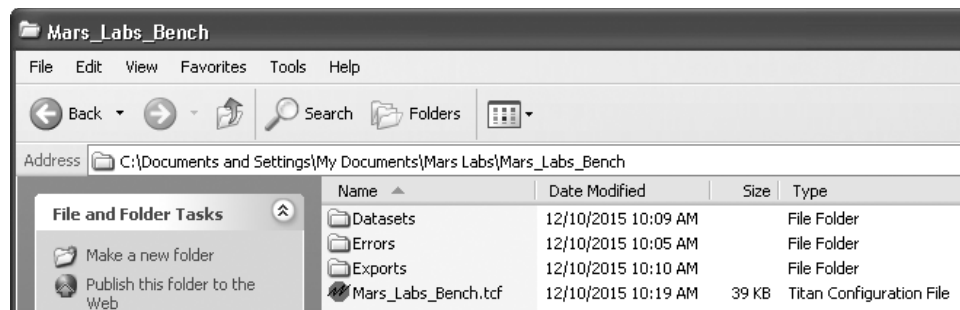

Data File Nomenclature

Since there can be several data files associated with a given test configuration, each data file is assigned a unique name. For example, for a test configuration called ‘LabTest’, the name of a recorded data file might appear as “LabTest_0004.tdf” where:

‘LabTest’ is the test name

‘_0004’ indicates the fourth recorded dataset

NOTES:

1. Test files that are recorded remotely have a ‘-r’ or ‘-e’ appended to the file name:

Sample_Test_0002-r.tdf

Sample_Test_0002-e.tdf

An ‘-e’ in the file name indicates that the device’s Error light was on when the data was recorded, and that data should be reviewed for errors.

2. Test files that are imported from alternate locations will always have an ‘-i’ appended to the file name: Imported_Test_003-i.tdf

File Renaming

TCS supports file renaming, which permits data files (.tdf files) to be freely renamed and viewed in the TCS Export window. There are a few operational and naming constraints to be aware of, however:

Viewing Files

If you are in the 'Export and Review' tab when you change a file name, you will need to refresh the screen in order to see the new name in TCS. A simple way to do this is to click on the 'Browse Remote Files' tab, and then click on the 'Export and Review' tab. The newly renamed file will appear in the list.

File Indexing

The last four digits of a file name are used by TCS to set the next local file index number. This means that if you change the four-digit suffix in a test file, TCS will use that to establish the next index value.

For example, if a file called "test_0001.tdf" is changed to "test_1234.tdf", TCS will use '1234' to establish the next locally-recorded file name, which will become "test_1235.tdf". Also, TCS will always use the highest value it finds in any test name suffix to establish the next local file index value, regardless of the day or time when the test actually occurred.

Valid File Names

TCS will allow any renamed file to be reviewed in the Export window so long as an underscore ("_") appears somewhere in the file name. Valid file names include "mytest_", "my_test", and "_mytest".

File Suffix Nomenclature

1. At least one file in the list must have a four-digit suffix. If no file includes a four-digit suffix, TCS will issue an error message when trying to record a new file:

"Error creating file. Please check your directory permissions and try again. Could not find any recognizable digits."

TCS will allow you to dismiss the message and continue, but a new file will not be created.

2. Valid numerical suffixes must always be preceded by an underscore and be four digits long. If less than four digits are in the name, TCS will issue an error message when trying to record a new file:

"Error creating file. Please check your directory permissions and try again. Index and length must refer to a location within the string.
Parameter name: length"

TCS will allow you to dismiss the message and continue, but a new file will not be created.

TCS Menus

The menus in TCS allow you to perform a variety of operations, including basic Load/Save test operations, advanced control of connected Titan devices, and data viewing options in the Runtime screen. A description of TCS menus follows.

Test:



‘New Test’ opens a New Test window to create a new test.

‘Save’ creates a directory with the same name as the current test name and places the directory in the root path location. The current test is saved in this directory. If the test is saved again after making changes, TCS will display a warning message about overwriting the test file.

‘Save As’ allows you to save the current test with a different name. ‘Save As’ creates a directory with the same name as the new test name and places the directory in the root path location. The new test is saved in this directory.

‘Load’ allows you to load an existing test. You will be presented with an ‘Open’ dialog box where you can search for and select an existing test file. TCS test files have the ‘.tcf’ (Titan Configuration File) extension.

Device:

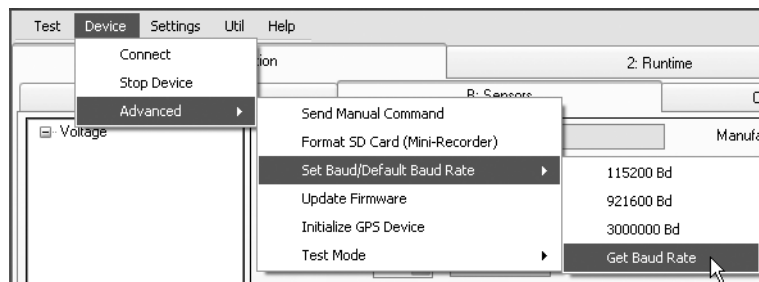

‘Connect’ is used to connect and disconnect the selected Titan device. This command performs the same function as pressing the ‘F1’ function key.

The ‘Stop Device’ command stops the connected device.

The Advanced menu allows you to access advanced program features:

‘Send Manual Command’ allows you to send manual commands to the connected Titan device. For a complete list of the available commands, refer to the *ICD Specification for Titan Recorder Devices*.

‘Format SD Card (Mini-Recorder)’ allows you to format the SD memory card in the Mini-Recorder.

NOTE: New memory cards should always be formatted in the Mini-Recorder using the 'Format SD Card' selection in the DEVICE menu. Use the following procedure:

1. Insert the memory card to be formatted into the Mini-Recorder, and then connect the Mini-Recorder to the PC via USB.
2. Launch TCS
3. In TCS, connect to the Mini-Recorder ('F1 - Connect')
4. Select 'Format SD Card (Mini-Recorder)' from the DEVICE menu
5. A warning message will be displayed:

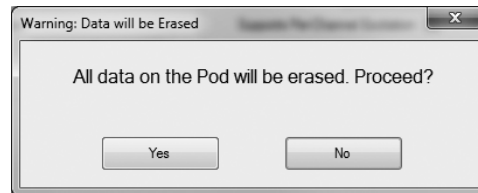

6. Click 'YES' to proceed, and the card will be formatted. When the formatting operation is complete, a 'Format Complete' message will be displayed:

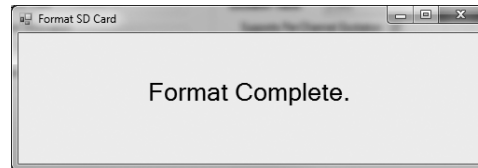

7. Close the message window and disconnect in TCS, or proceed with test configuration and setup.

Device Advance sub-menu commands (cont.):

'Set Baud/Default Baud Rate' sets the selected baud rate of the device COMM port by issuing two commands to the connected device:

SET_BAUD_RATE immediately changes the baud rate at the COMM port (non-persistent)

SET_DEFAULT_BAUD_RATE which sets the baud rate when the device powers up.

A third command, 'Get Baud Rate', returns the current baud rate of the connected device

Device Advance sub-menu commands (cont.):

The ‘Update Firmware’ option allows you to update the firmware of the connected device by minimizing TCS and launching the Titan Programmer and the Titan Programmer manual. The manual will walk you through using the Programmer once it is open.

NOTES:

1. Firmware updates can only be performed on Titan Mini-Recorders, Pods, and DACs via a USB connection; Ethernet and serial connections are not supported.
2. Firmware updates cannot be performed through a DAC or CPU. If necessary, reconfigure your system for a USB-only direct connection to the Titan Input device before updating.
3. When updating a Pod or Mini-Recorder, TCS requires a connection to the device **before** entering the Programmer.
4. When updating a DAC, TCS does not require a connection to the DAC, but the DAC **must not** be connected to a Pod or Mini-Recorder

The ‘Initialize GPS Device’ command initializes the GPS device for the proper baud rate and messaging configuration to communicate with TCS.

‘Test Mode’ allows you to enable/disable Test Mode, which applies a ramp wave on all configured channels.

Settings:

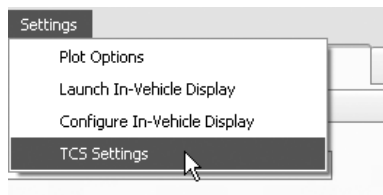

The *Settings* menu allows you to change basic settings in TCS and select alternate display options.

‘Plot Options’ - Displays a window that allows you to select alternate viewing options for the Runtime plot data (see figure). Viewing options include

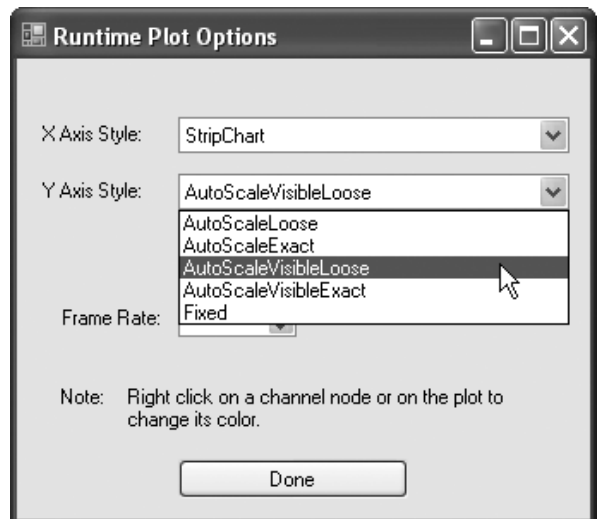

Settings (cont.):

‘Launch In-Vehicle Display’ - Selects an alternate display interface that uses keyboard-based control. This display is useful when controlling TCS with a standard PC mouse or trackpad is impractical, such as during an in-vehicle test. For details on the In-Vehicle Display, see pg 134.

NOTE: The ‘Launch In-Vehicle Display’ function can also be accessed on the Configuration screen using function key F11, ‘In-Vehicle Display’.

‘Configure In-Vehicle Display’ - Allows you to configure the function keys for the In-Vehicle Display. For details, see ‘Configure In-Vehicle Display’ pg 138.

‘TCS Settings’ - Displays a window for changing default settings in TCS. TCS Settings allows you to change the root path, override the export path, import and convert data from older versions of TCS, specify startup condition, and enable or disable Monitor Mode (see descriptions on next page).

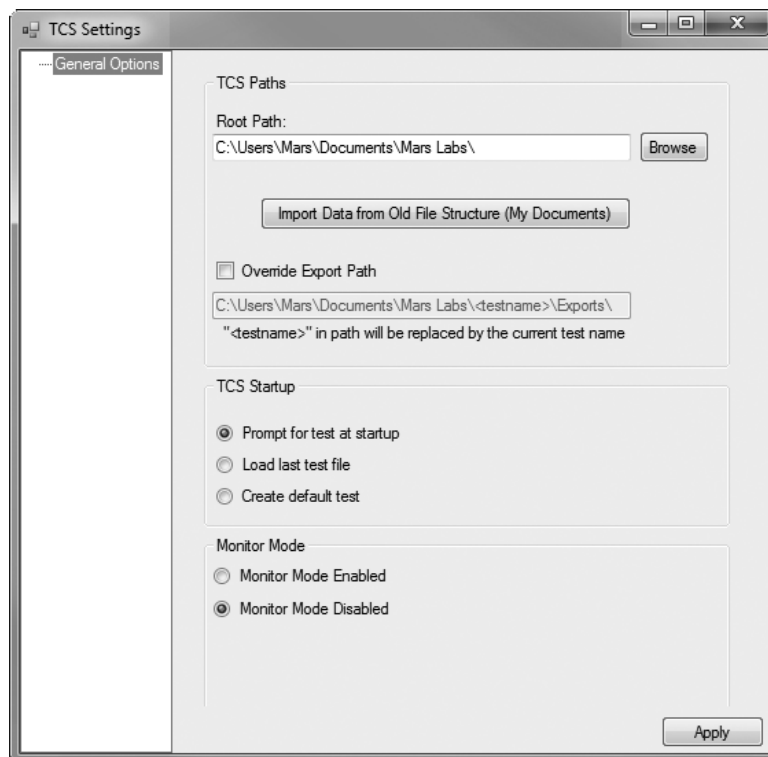

TCS Paths:

The TCS Paths pane displays the Root Path, Export Path override feature, and an 'Import Data from Old File Structure' button.

Initially, the Root Path defaults to:

'My Documents\MarsLabs\<current_test_name>'

To change the root path, enter the new path in the Root Path text field.

The Export Path defaults to the Root Path. To change the Export Path, click on the 'Override Export Path' checkbox and specify a new path.

The 'Import Data from Old File Structure (My Documents)' button converts the file structure from previous versions of TCS (prior to v2.6.4) to the new file structure. Clicking on the button automatically converts all of the files in the Root Path.

NOTES:

1. The new file structure organizes the data by test name, whereas the older file structure organized the data by type.
2. When data is imported, the old file structure remains untouched - it is not deleted

TCS Startup:

The TCS Startup pane allows you to select the desired startup condition using the radio buttons.

Monitor Mode:

The Monitor Mode pane allows you to enable or disable Monitor Mode for Titan CPU configurations. When Monitor Mode is disabled, the Monitor Mode checkbox will be greyed out in the CPU Settings pane on the Device Configurations screen:

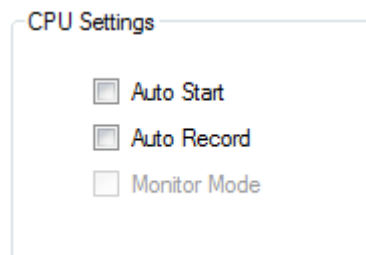

NOTE: The first time TCS is installed and run, Monitor Mode will be disabled. Enable Monitor Mode by clicking on the Monitor Mode ENABLED radio button and selecting 'Apply'. TCS will remember this state (and other changes made in the TCS Settings window) for all new tests.

Util (Utilities):

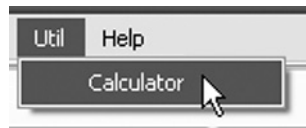

‘Calculator’ - Displays a multifunction calculator. To use the calculator, simply enter the desired equation into the expression field and press ‘Calculate’. The allowable operators, functions and constants are as displayed.

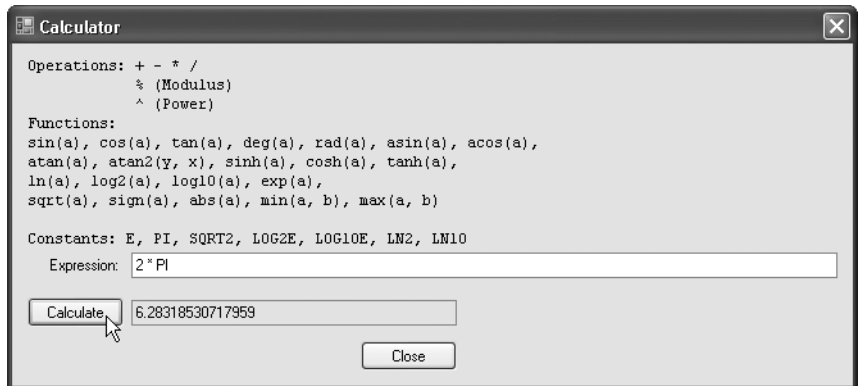

Help:

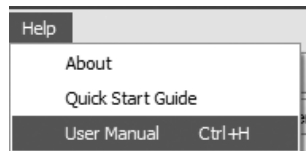

‘About’ - Displays a standard information message box about the TCS application

‘Quick Start Guide’ - Launches the Titan Quick Start Guide.

‘User Manual’ - Displays context-sensitive information from the embedded TCS User Manual. When evoked, either from the menu or by pressing ‘CTRL H’, the TCS User Manual launches and displays information about the currently displayed TCS screen.

Note: To view the Quick Start Guide and User Manual you must have Adobe Acrobat Reader installed. The reader is available from Adobe:

www.adobe.com/products/acrobat

In-Vehicle Display

The 'In-Vehicle Display' provides a simplified display/interface that is optimized for compact screens, such as laptops or tablet interfaces. When 'In-Vehicle Display' is selected, a new window replaces the standard TCS window, offering Test Control, Plot, and Digital Display display screens. Screen selection is made by pressing the LEFT or RIGHT cursor keys to switch amongst screens, or by selecting the appropriate tab on touch-screen devices.

NOTE: For information on using tablet interfaces with TCS, refer to application note APN-1021 - In-Vehicle Display Interfaces.

Test Control

The Test Control screen provides a convenient means for the driver to monitor test runs, test run times, and acquisition status:

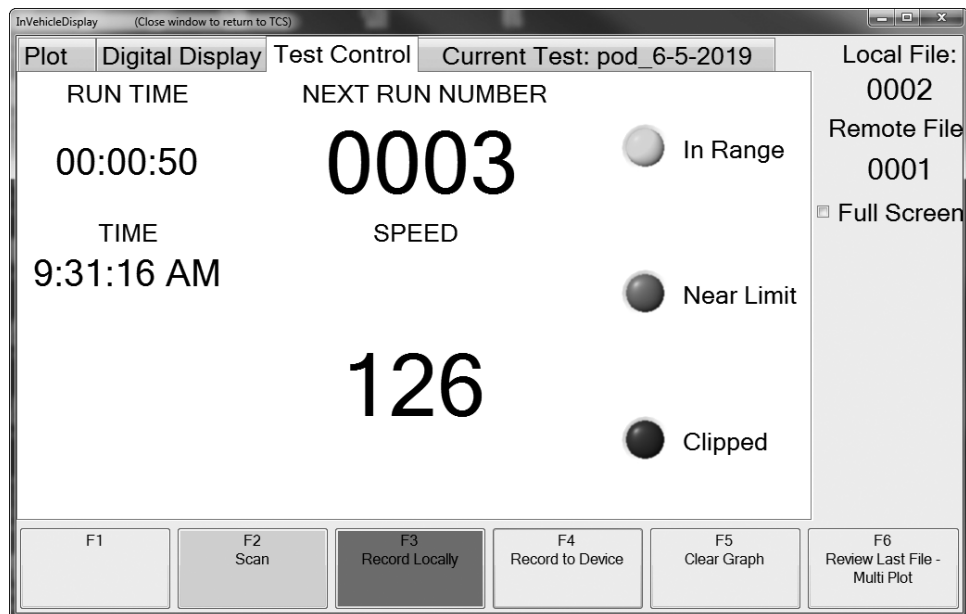

NOTES:

1. By default, the In-Vehicle display always appears in full screen mode. This provides the optimum display for the driver when viewing on a small monitor .
2. To change the default function key assignments, see 'Customizing the In-Vehicle Display', page 138.

Shown on the far right of the Test Control screen, the Local and Remote file indexes display the total number of test runs acquired. The large display in the upper middle of the screen displays the upcoming run. When a run is being recorded, the Run Time display shows the recording time of the data acquisition (hh:mm:ss). Virtual LEDs on the right indicate the status of the data being collected ('In Range', 'Near Limit', or 'Clipped'). The value beneath the 'Speed' display (Speed appears only when 'Wheel Force' is selected as a CAN source), shows the average linear speed from all four wheels.

To ensure the integrity of the test, the ‘Review Last File’ function key [F6 by default] provides a quick review of the most recently acquired data:

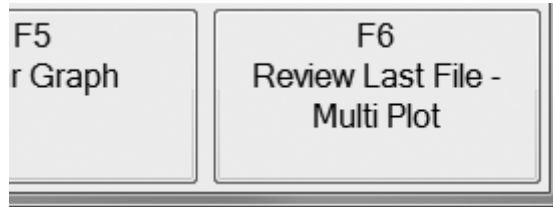

Selecting ‘Review Last File’ results in a display like the one shown below:

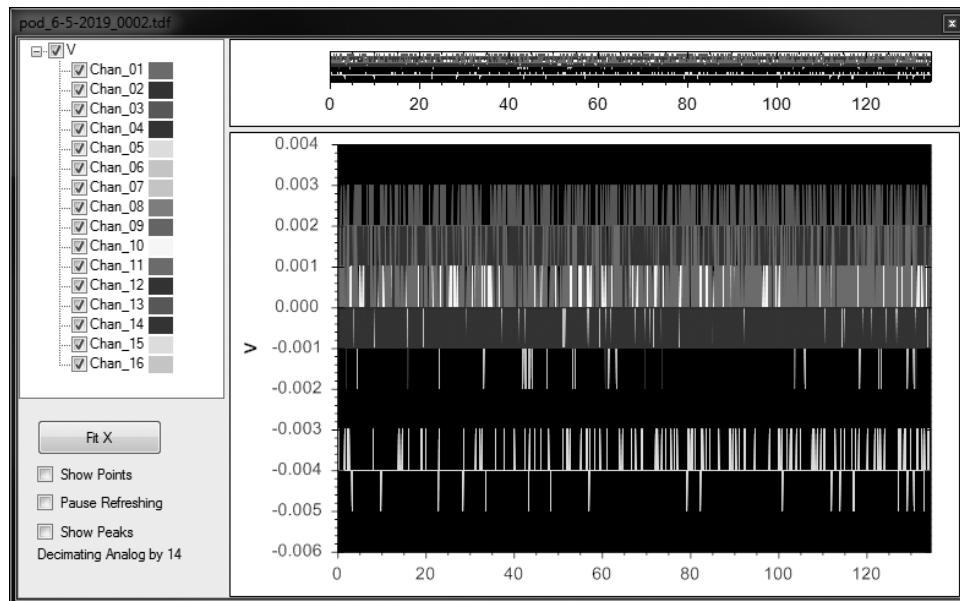

NOTE: By default, the Review Last File display always appears in full screen mode. Double-clicking in the Title bar will shrink the window.

To navigate in this window, use the Tab key to select one of the options in the left column and use the Space bar to toggle functions ON and OFF. For convenience, the following letter assignment can also be used:

- ‘A’ toggles the Fit X function
- ‘B’ toggles ‘Show Points’ ON and OFF
- ‘C’ toggles ‘Pause Refreshing’
- ‘D’ toggles ‘Show Peaks’ ON and OFF
- ESC (Escape) closes the Review window

To review channel data, use the Arrow keys and the Space bar to select and display desired channels.

NOTE: Two ‘Review Last’ functions are available in the Test Control window: the default selection (‘Review Last File - MultiPlot’) provides individual plot displays for each sensor type, while the other (‘Review Last File’ [function key not assigned]) provides for a single display. To add or change the function key assignments, see ‘Customizing the In-Vehicle Display’, page 138.

Plot

The Plot screen provides a continuously scrolling view of the data. Channels are selected using the UP and DOWN cursor keys, and the function keys are used to activate the recording, calibration, and review functions:

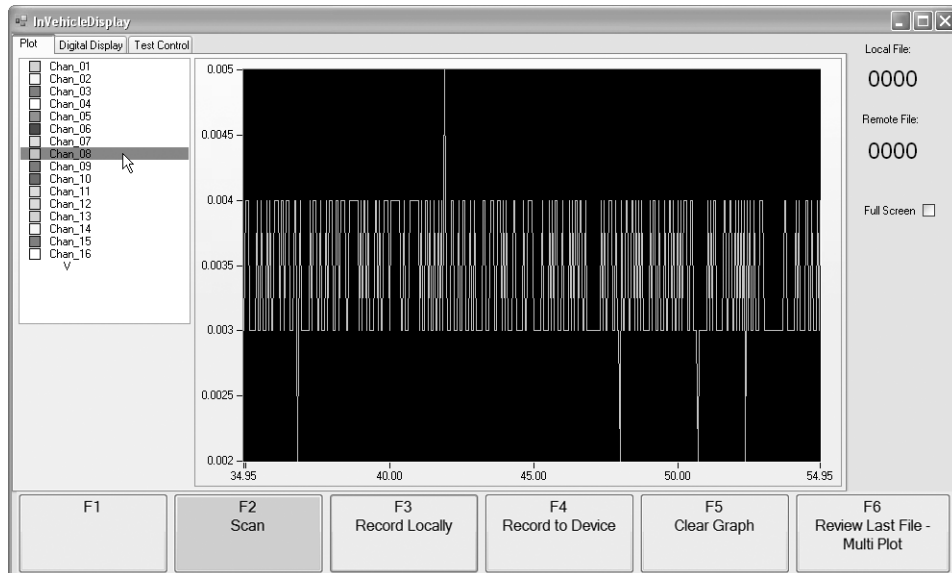

NOTE: The Plot display also incorporates the Plot Groups functionality (page 113), which provides a grouped display of related sensor types.

In this window, use the UP and DOWN arrow keys to select the desired channel to display.

Digital Display

The Digital Display screen provides a continuously updated numerical view of the data:

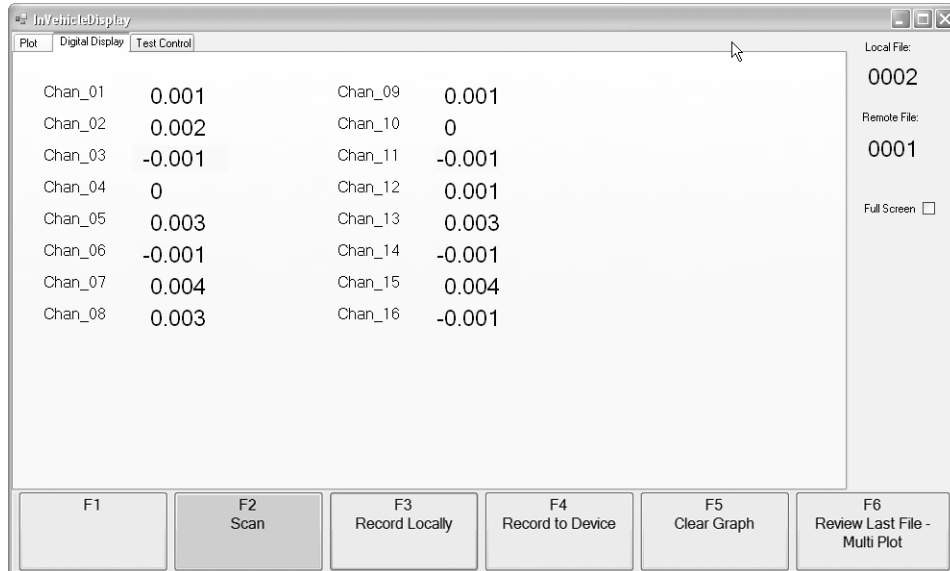

In the Digital Display screen, when two or more Titan devices are connected with a CPU, the UP and DOWN arrows are used to select the desired Pod or Mini-Recorder data to be viewed. The example below shows a CPU-based configuration monitoring 16 channels from a Pod connected to port 4.

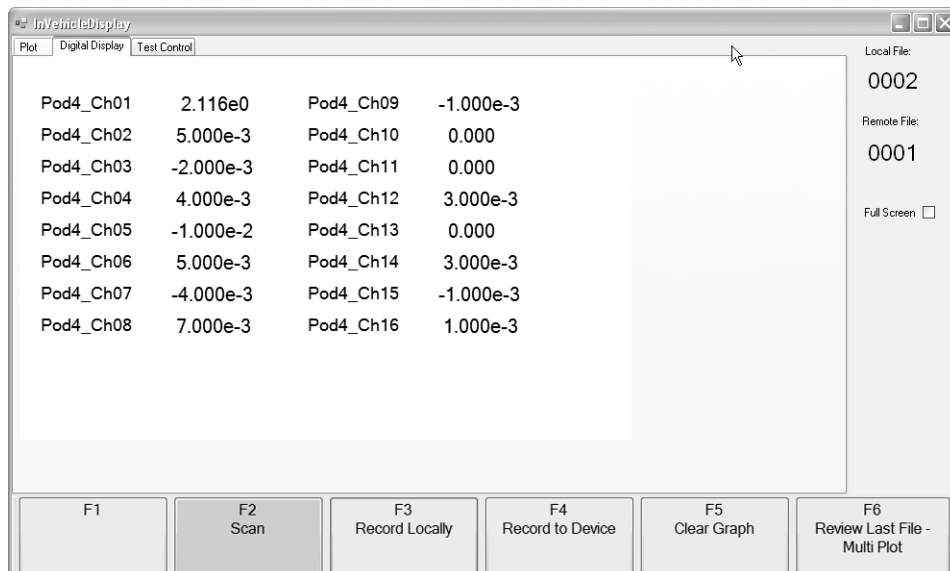

Customizing the In-Vehicle Display

The 'Configure In-Vehicle Display' window (located in the 'Settings' menu) allows you to assign specific operations to the function keys in the In-Vehicle Display. The operations are identical to those in the standard TCS window, and perform the same functions

After making the assignments, clicking on 'Apply' will apply the changes. The assigned labels will appear on the Function Key button bar in the IVD window.

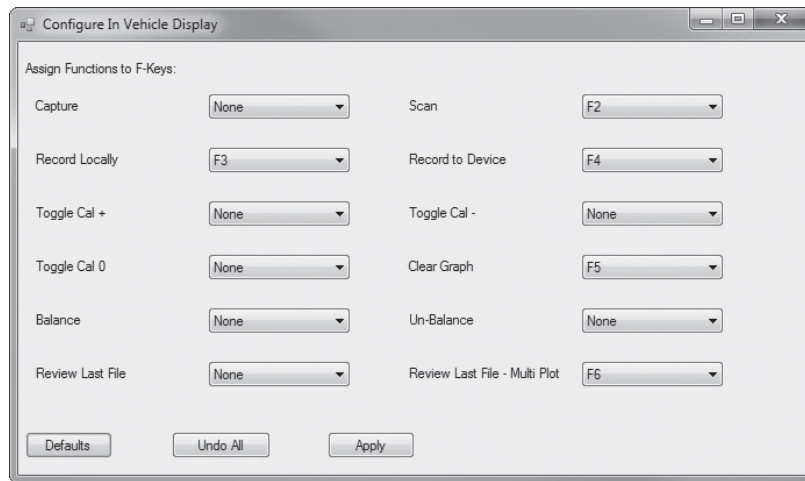

Launching into the In-Vehicle Display (Auto-launch)

You can customize TCS to launch directly into the In-Vehicle Display by creating a modified version of the existing TCS desktop shortcut.

To create an auto-launching IVD desktop shortcut, begin by making a *copy* of the TCS desktop shortcut and rename the copy “TCS_IVD”. Right-click on this new shortcut and select Shortcut/Properties:

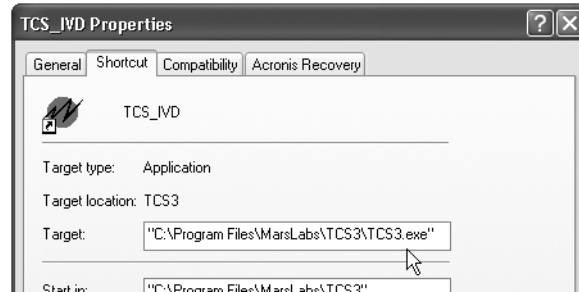

In the Target field, add the suffix “(space)--startivd” to the path name:

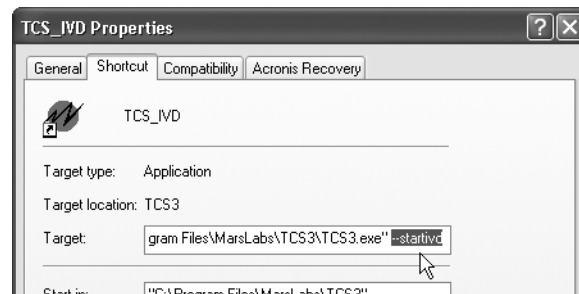

After making the change, select “Apply” and close out of the window.

When selected, the new shortcut will launch TCS into the In-Vehicle Display with the last test that was run. This means that if you intend to run a test that is different from the last test, you will first need to configure, run (scan), and save the test in TCS *prior* to using IVD in auto-launch mode.

Data files acquired with IVD auto-launch are placed in the Dataset folder in the location of the last test that was run.

NOTES:

1. **Prior to auto-launching IVD, make sure the test device is connected and powered. If no device is connected/powered, the program will issue an error message.**
2. **When closing out of auto-launch IVD, the program will terminate instead of exiting back into TCS.**

Loading from an Existing Test

To load an existing test, click on the ‘Browse’ button and navigate to the location of the desired test. By default, TCS stores all tests in a folder called ‘Mars Labs’ located in the current user’s ‘My Documents’ folder (for Windows XP systems), or the ‘Documents’ folder (for Windows Vista and later systems). Simply click on the desired .tcf or .tdf file to load the test configuration.

NOTE: The root path is displayed in the TCS window title bar. To change the path use the ‘TCS Settings’ option found in the ‘Settings’ menu.

You may also load an existing test from a file located outside of the Mars Labs folder. When you load a test this way, TCS will present a series of test configuration import options and status messages as shown below.

When you select any .tcf or .tdf file located outside of the Mars Labs folder, TCS will present a message window that the file is not in the root path and ask if you wish to import it so that TCS can use it:

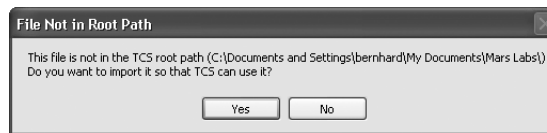

1. If you click ‘YES’, TCS will create a new folder in the root directory and import the TCF file and any TDF files associated with the test, and display an status message about the action:

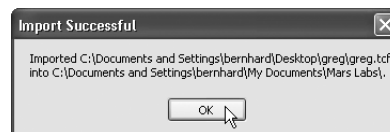

If a folder by the same name already exists in the root directory, and files having the same name exist there also, TCS will ask permission to overwrite them; if you select ‘NO’, only the unique file names will be imported. If you select ‘CANCEL’, the import will be aborted.

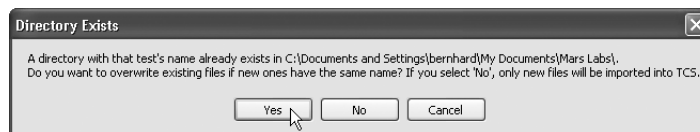

2. If you click ‘NO’, TCS will display a message that it loaded the settings in the selected configuration file without creating a new folder. A new folder will be created, however, if either the test is saved or data is collected locally.

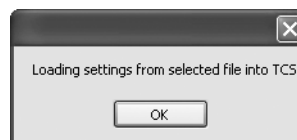

This page intentionally left blank

Running with RS-422 (COMM)

There are circumstances when you may need to configure communication with a single Mini-Recorder or Pod via RS-422 (COMM) instead of USB. Such circumstances include:

1. Difficulty operating in Low Speed mode under Windows Vista.
2. Issues with USB 3.0
3. The need to operate using cable runs that are longer than USB will support

To configure communication with a Mini-Recorder or Pod via RS-422, you will need USB/RS422 adapter hardware and device drivers. Both are available from Mars Labs and from Future Technology Devices International (FTDI):

MarsLabs: MLCBL10046 - USB/422 Titan Serial Adapter Cable

FTDI: USB-RS422-WE (Cable)

Note: the un-terminated end must be wired to an RJ-45 plug matching the Titan pinout - contact the factory for wiring details

USB-COM422-PLUS2 (PCB)

The adapter should be installed close to the PC that is running TCS. This permits longer cable runs to be used with a single Mini-Recorder or Pod.

NOTES: *When using the RS-422 connection, you will need to power the Mini-Recorder or Pod from an external source.*

In addition to obtaining the adapter, you will need to install the device driver. The device driver is found on the TCS installer disc, and can also be obtained from www.ftdichip.com on the Drivers\VCP page.

After installing the driver, if you experience blocky or slow data at the Low Speed rate over RS-422, try adjusting the Receive Threshold FTDI driver setting:

1. Open the Windows Device Manager
2. Under 'Ports', right-click on the port you are using and select 'Properties'
3. Switch to the 'Port Settings' tab
4. Click on 'Advanced'
5. In the USB Transfer Sizes box, change 'Receive (Bytes)' to '1024'
6. Click 'OK' to close both windows and select 'NO' if requested to restart the PC.
7. Unplug the FTDI and plug it back in.
8. Connect the device and open it with TCS

Baud Rate Considerations using the COMM Port

Use of the COMM port introduces some important new considerations depending on the configuration. These are described below.

1. Pod to PC:

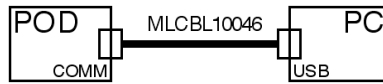

A serial cable such as the MLCBL10046 supports a standard baud rate of 921,600 which permits a maximum scan rate of 2500 samples/sec. Transfer of remote data from the pod is also supported at this rate. A 3M baud rate is possible if a high speed serial connection is used in place of the MLCBL10046. The baud rate setting in TCS should always match the baud rate of the connected equipment.

2. Pod to DAC to PC:



Operation with a DAC reduces the scan rate to 1200 samples/sec at a baud rate of 921,600. DAC operation does not support the transfer of remotely recorded files. File transfer can either be done using configuration #1 above, or by removing the SD memory card and using a card reader in the PC.

3. Pod to CPU:

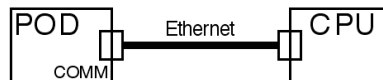

When a CPU08 or CPU08V is used, it automatically sets all connections to 3M. CPU operation also disables remote recording from all connected pods. Since the connection to the CPU is done over a LAN, the baud rate connection in TCS is not a concern.

4. Pod to DAC to CPU:



As with configuration #3 above, the CPU automatically sets all connections to 3M. When a DAC is part of the system, however, the scan rate is limited to 1200 samples/sec. As with configuration #3, the baud rate connection in TCS is not a concern.

ICD Baud Rate Commands

The baud rate of the COMM port on Titan devices is set using manual commands executed in TCS (select 'Manual Command' [F10]). The following is a list of the commands that address baud rate settings for the Mini-Recorder/Pod and DAC.

For the Mini-Recorder/Pod:

SET_BAUD_RATE (command is not persistent)

Syntax: SET_BAUD_RATE <VALUE><send>

Summary: Sets the baud rate of the COMM port. A valid value will not return an ACK with this command.

Valid Inputs: 115200, 230400, 921600, 1843200, 3000000

Example: SET_BAUD_RATE 921600

Valid Outputs: NONE, ERROR

Ex. Response: NONE

GET_BAUD_RATE

Syntax: GET_BAUD_RATE <send>

Summary: Returns the baud rate setting of the COMM port.

Valid Inputs: NONE

Valid Outputs: 115200, 230400, 921600, 1843200, 3000000

SET_DEFAULT_BAUD_RATE (command persistent, requires power cycle after setting)

Syntax: SET_DEFAULT_BAUD_RATE <VALUE><send>

Summary: Sets the baud rate of the COMM port at power up. If no default is set ('0') the board will power up at 921600 for high speed devices.

Valid Inputs: No default set: 0

Valid rates: 115200, 230400, 921600, 1843200, 3000000

Example: SET_DEFAULT_BAUD_RATE 921600

Valid Outputs: ACK, ERROR

Ex. Response: ACK

GET_DEFAULT_BAUD_RATE

Syntax: GET_DEFAULT_BAUD_RATE <send>

Summary: Returns the default baud rate setting of the COMM port.

Valid Inputs: NONE

Valid Outputs: 115200, 230400, 921600, 1843200, 3000000

For the DAC:

SET_DEFAULT_POD_RATE (command persistent, requires issuing a 'RUN' command afterwards [see below] and then power cycling to take effect)

Syntax: SET_DEFAULT_POD_RATE <VALUE><send>

Summary: Sets the default baud rate of the DAC COMM POD port.

Valid Inputs: 921600, 3000000

Example: SET_DEFAULT_POD_RATE 921600

Valid Outputs: ACK, ERROR

Ex. Response: ACK

If the DAC firmware is version 1.10 or later, no additional steps are required. Disconnect from TCS and power-cycle the device.

If the DAC firmware is 1.9 or earlier, you must also issue a 'RUN' <send> after issuing the SET_DEFAULT_POD_RATE command. The response to the RUN command will be "Error reading response". This is an expected response. After issuing the RUN command, disconnect from TCS and power-cycle the device.

GET_DEFAULT_POD_RATE

Syntax: GET_DEFAULT_BAUD_RATE <send>

Summary: Returns the default baud rate setting of the DAC COMM POD port.

Valid Inputs: NONE

Valid Outputs: 921600, 3000000

For more information on Titan Device Comm Baud Rates, refer to Applications Note APN-1006 - Titan Device Comm Baud Rates

Asset Tag and Customer Information Data Entry

Titan device firmware (v0.31.10 and above) adds the capability for entering and storing asset tag and other customer-specific information on the device. A dedicated 'Asset Tag' field permits entry of up to 15 characters, while a dedicated 'Customer Information' field supports up to 31 characters. Once the information is entered, these fields can be locked to prevent changes or tampering. The information is entered using the Manual Command window in TCS (F10 - Manual Command) using the commands listed below.

To use the commands:

1. Determine beforehand what information will be entered in these fields.
 - You may enter up to 15 characters (not including the asterisk [*]) for the Asset Tag field.
 - You may enter up to 31 characters (not including the asterisk) for the Customer Information field.
 - Character strings may not include a colon (:), a Carriage Return <CR> or a Line Feed <LF>.
2. Enter the Asset Tag information as defined, adding an asterisk to the end of the string as shown. *Do not set the lock.*
3. Enter the Customer Information as defined, adding an asterisk to the end of the string as shown. *Do not set the lock.*
4. Using the GET_ASSET_TAG and GET_CUSTOMER commands, confirm that the assigned field values are correct.
5. Issue the SET_ASSET_LOCK command. The Asset Tag and Customer Information fields will then be permanently locked, and can no longer be changed.

The Commands

SET_ASSET_TAG

Syntax: SET_ASSET_TAG<space><15 char string>* <send>
Summary: Fills the Asset Tag field with up to 15 characters
Valid Inputs: <15 char string>
Example: SET_ASSET_TAG ABC-123*
Valid Outputs: ACK, ERROR

GET_ASSET_TAG

Syntax: GET_ASSET_TAG <send>
Summary: Returns the Asset Tag character string
Sample Output: "ABC-123"

SET_CUSTOMER

Syntax: SET_CUSTOMER<space><31 char string>* <send>
Summary: Fills the Customer Information field with up to 31 characters
Valid Inputs: <31 char string>
Example: SET_CUSTOMER My Titan BMS Device*
Valid Outputs: ACK, ERROR

GET_CUSTOMER

Syntax: GET_CUSTOMER <send>
Summary: Returns the Customer Information character string
Sample Output: “My Titan BMS Device”

SET_ASSET_LOCK

Syntax: SET_ASSET_LOCK <send>
Summary: Permanently locks the Asset Tag and Customer Information fields.
Warning: Once used, this command cannot be undone!
Example: SET_ASSET_LOCK
Valid Outputs: ACK, ERROR

GET_ASSET_LOCK

Syntax: GET_ASSET_LOCK <send>
Summary: Returns the state of the Asset Tag and Customer Information field locking mechanism.
Sample Output: “LOCKED”, “UNLOCKED”

Troubleshooting

If you are having difficulties installing or configuring TCS, refer to the troubleshooting section below. This section addresses common issues with the installation and setup of TCS. If your specific issue is not addressed, please contact the factory for additional assistance.

Issue: Dotnet installed, but TCS doesn't run

Dotnet is installed, but TCS doesn't run, or TCS produces an error message about updating dotnet.

Solution

TCS requires Microsoft .NET Framework (AKA "Dotnet") version 3.5 or greater be installed (older versions of Dotnet are not compatible with TCS). The Dotnet installer is found in the dotnet installer folder on the TCS installation disc.

Issue: Titan device drivers not installed

When a Titan device is connected to USB, a 'Found New Hardware' window appears asking you to locate the Titan device driver.

Solution

The Titan device driver needs to be installed. The driver is found on the installation disc (filename "titanvcom.inf"). If the 'Found New Hardware' window is still active, simply navigate to the installation disc, select the driver and respond to the prompts. If the 'Found New Hardware' window is not active, you will need to install the driver using the Windows Device Manager as follows:

1. Keep the Titan device plugged in and open the Device Manager. The Device Manager is located by right-clicking on the My Computer icon and selecting 'Properties'. The Device Manager is located under the 'Hardware' tab.

2. With the Device Manager open, double-click on 'Ports' to reveal the missing Titan driver (the missing driver may have a yellow question mark superimposed on the missing driver icon) :

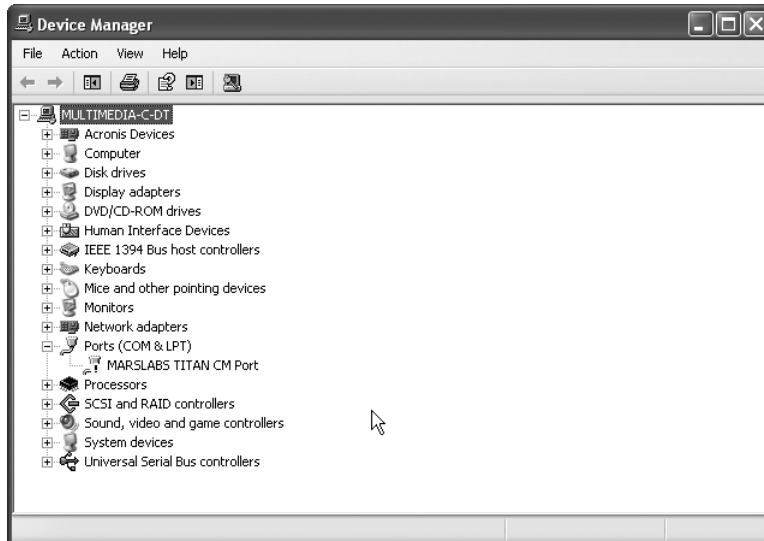

3. Right-click on the missing driver and select 'Update Driver':



4. Follow the Hardware Update prompts to perform the update. In the first window, select the option to install the driver from a specific location and then click 'Next':



5. In the next window, select the option to choose the driver to install, and then click 'Next':

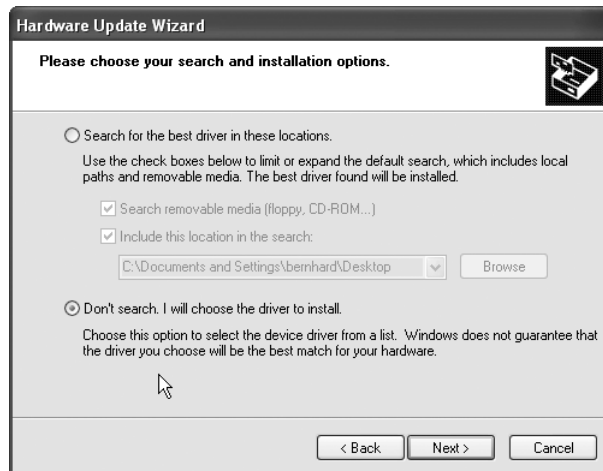

6. Navigate to the location of the VCOM driver and select it.

Path: C:\Program Files (x86)\MarsLabs\TCS3\Drivers

Hardware Update may display a warning message as shown. Click 'Continue Anyway' to dismiss the message and install the driver:

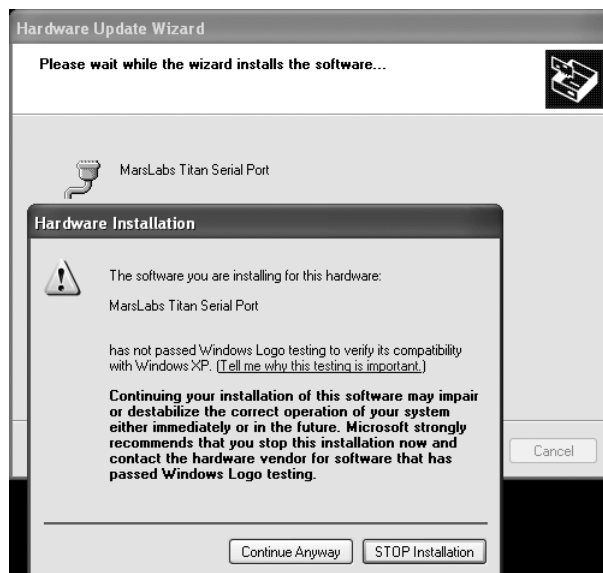

7. When the Hardware Update is complete, it will display a message like that shown below. Click 'Finish' to complete the installation.



8. The Device Manager will now display the Titan driver and COMM port that the Titan device is connected to:

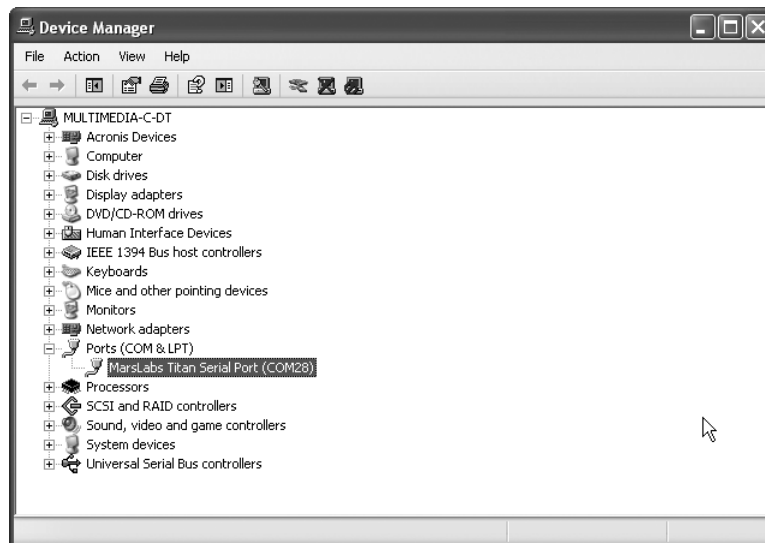

NOTE: Recent Windows updates include the STMicro VCOM driver, which works with the Titan Mini-Recorder or Pod. If you have this update, you may not need to install the Titan driver separately.

Notes & Known Issues

This section offers additional operational information about TCS not covered elsewhere.

Known Issues (Windows 10 Installation)

Due to changes in Windows 10, the standard installation of Titan Control Software (TCS) may not function correctly. Windows 10 users should install TCS by right-clicking on the TCS installer icon and selecting 'Run as Administrator', and then follow the prompts to install TCS. When the installation is finished, a modified TCS3 shortcut icon will appear on the desktop. Double-clicking the icon will produce a dialog box asking if you want to allow the application to run on the machine. Click 'Yes', and TCS will launch and function normally.

Known Issues (Configuration & Connectivity)

CPU Configuration Issues in a Mixed Titan System

Mixing Titan 'B' series devices (Titan BMS & BSG) with Titan 'C' series devices (Titan CAI) in CPU-based system configurations will result in scaling errors and synchronization inconsistencies between the device type outputs, both for realtime data display and for data export. The Titan CPU does not compensate for these disparities; such 'mixed system' configurations should be avoided.

Connectivity Issues in Windows 8

Mini-Recorders and Pods with firmware versions 0.31.0 and earlier have a known USB communications issue with Windows 8. ***This issue was resolved in firmware version 0.32.0, and Mars Labs recommends updating the firmware to the current version. Firmware update information can be found on the Mars Labs Knowledge Base (<http://marslabs.com/wiki/doku.php>)***

If you must run with Windows 8 with the older firmware, connectivity can be established by performing the following:

- 1) Connect the Mini-Recorder to Auxiliary Power
- 2) Connect the Mini-Recorder to the computer with a USB cable.
- 3) Click "Query Serial Devices" and select the device in the menu.
- 4) Click 'Connect' (F1). This will cause the device to hang. You should hear the device making a USB connection 'chime' several times.
- 5) Click "Disconnect" (F1), and then remove the USB cable from the device.
- 6) Re-connect the USB cable to the device. Click "Query Serial Devices", then click "Connect" (F1). TCS will establish communication with the device and populate the "Device Information" fields.

Connectivity issues with Windows 7/USB 3.0

Mini-Recorders and Pods with firmware versions 0.31.0 and earlier can experience intermittent or limited USB connectivity on new PCs that include combined USB 2.0 and USB 3.0 ports. The issue appears to occur primarily in laptop systems, but may also extend to desktop systems. ***This issue was resolved in firmware version 0.32.0, and Mars Labs recommends updating the firmware to the current version. Firmware update information can be found on the Mars Labs Knowledge Base (<http://marslabs.com/wiki/doku.php>)***

If you must run with Windows 7 with the older firmware, an alternate connection can be made using the device COMM port instead of USB. This type of connection is accomplished using the USB/422 Serial Cable Adapter (MLCBL10046) or an equivalent (USB/422) interface.

When using the COMM port, connectivity between the Titan Device and TCS involves matching the baud rates. For Titan devices, the default baud rate is initially set at the factory to 921,600; this is the default baud rate for the device upon power-up. This is the rate that should be selected in TCS.

If necessary, the default baud rate of the Titan device can be changed by issuing a special ICD Baud Rate command in TCS. Since the command will affect the baud rate at the COMM port, such commands are best issued using a USB connection (baud rate settings have no effect on USB connections). To change the baud rate, perform the following:

1. Connect to the Titan device via USB
2. Open the Manual Command window (function key F10 in the Configuration screen) and enter the command:

```
SET_DEFAULT_BAUD_RATE <value>
```

where valid baud rate values are 115200, 230400, 921600, 3000000.

As you enter the command, be sure to leave a single space between `_RATE` and the `<value>` parameter.

3. Click 'SEND'. The device will respond with an acknowledgement (ACK) or an ERROR if the command was invalid.
4. After changing the baud rate, you will need to cycle the power on the Titan device. After the device completes its initialization, the new baud rate will be in effect.
5. The `SET_DEFAULT_BAUD_RATE` command has a companion 'GET' command that is used to report the current default baud rate setting:

```
GET_DEFAULT_BAUD_RATE <send>
```

Use this command if you are unsure of the current default baud rate value.

For more information on using the COMM port, see *Running with RS-422 (COMM)*.

Connectivity issues between a Titan DAC and Mini-Recorder or Pod

If you experience connectivity issues between Titan DACs and Mini-Recorders or Pods, the reason can be due to a mismatch of baud rates between the devices. This is easily corrected by issuing new baud rate commands for the devices using the procedure described below. The procedure should be performed on a PC with USB 2.0 ports.

For the Mini-Recorder/Pod:

1. Make sure that the Mini-Recorder is powered from the power adapter. Using a USB cable, connect the Mini-Recorder to the PC.
2. Launch TCS, select 'Mini-Recorder' as the device type, and then click 'Create'.
3. Connect to the Mini-Recorder (function key F1 – 'Connect')
4. Open the Manual Command window (function key F10)
5. In the 'Command' field, enter the following:

`GET_DEFAULT_BAUD_RATE`

This command will return the baud rate setting of the COMM port. If the value is '921600', skip to step 7. If any other value is returned, continue with step 6.

6. In the 'Command' field, enter the following:

`SET_DEFAULT_BAUD_RATE 921600`

When you enter the command, be sure to leave a single space between '_RATE' and the value '921600'. Click 'Send'. The response should be 'ACK' (acknowledge).

7. Click 'Done' to close the Manual Command window. Disconnect from TCS (F1), remove the USB connection, and then remove power from the Mini-Recorder/Pod.

For the DAC:

1. Power the DAC from the power adapter. Using a USB cable, connect the DAC to the PC.
2. In TCS, select 'New Test' from the Test menu. Select 'Mini-Recorder + DAC' as the device type, and then click 'Create'.
3. Connect to the DAC (function key F1 – 'Connect'). Note: The DAC device information field will remain empty after the connection is established.
4. Open the Manual Command window (function key F10)

5. In the 'Command' field, enter the following:

```
GET_DEFAULT_POD_RATE
```

This command will return the baud rate setting of the POD COMM port. If the value is '921600', skip to step 8. If any other value is returned, continue with step 6.

6. In the 'Command' field, enter the following:

```
SET_DEFAULT_POD_RATE 921600
```

When you enter the command, be sure to leave a single space between '_RATE' and the value '921600'. Click 'Send'. The response should be 'ACK' (acknowledge).

7. In the Command field, type RUN and click the 'Send' button. The response will be "Error reading response". This is an expected response to the RUN command. Click 'Done' to close the window.

8. Click 'Done' to close the Manual Command window. Disconnect from TCS (F1), remove the USB connection, and then remove power from the DAC.

Known Issues (Operation)

File Partitioning

When file partitioning is enabled for Titan Mini-Recorders, the overhead associated with the partitioning operation will result in some lost data. The data loss is a function of the scan rate. The amount of data loss can vary from approximately 1/3 second to 1 second or more between partitions, depending on the scan rate selected. To minimize data loss (and possibility of recording failure) when file partitioning is enabled, large chunk sizes (~10M) should be selected when large files (~100KB or greater) are in use. Where possible, best results will be obtained with lower scan rates.

TCS Triggers/Alarms

Older FTDI drivers can cause crashes on WinXP-32 systems when the Alarm function is enabled. If you experience a crash when using the Alarm function, check to make sure that the FTDI driver is up to date.

Negative Gains

1. For a negative gain setting, when using Vcal or Rcal, the cal target on that channel will be inverted.
2. Negative gains are not backwards compatible with old releases of TCS.
3. Physical Calibration (PCal) does not support negative gains.
 - This is an issue if the Pcal sensor has an offset

CPU Configuration

1. For data exports from CAI devices created in CPU-based configurations prior to TCS v3.3.12, users should consult Mars Labs for validation.
2. When using the CPU, if you receive a network error you must Disconnect and then Re-Connect in TCS to restore the connection. Remote recordings will continue on the device uninterrupted, however.
3. When 'Monitor Mode' is enabled, the 'Auto Start' and 'Auto Record' functions are disabled.
4. If the CPU loses power while scanning, all independently-powered Titan Input devices (Mini-Recorders or Pods) must be power-cycled in order to resynchronize the system.

File Date/Time issues for copied files

TCS keeps track of the actual test date using the file's creation date. If a TDF file is copied using Windows Explorer, the file's creation date is changed to reflect the copied date, which means the actual test date is then lost.

TCS (versions 3.07 & later) addresses this by setting the file's creation date and modification date to the time at which the test is started. If the creation date is changed later as the result of a copy operation, the modification date will still reflect the actual test date (TCS 3.0.6 and earlier versions did not include the modification date with the file).

Remote Recording Issues with large files

Due to the speed at which data can be written to the SD card, there is a limitation on the amount of data that remote recording will support. Tests performed at the factory have determined that file sizes of about 200KB is the practical upper limit for remote recording (independent of the scan rate). This file size is the equivalent of 1 analog sensor (i.e. a default sensor) plus 700 digital (CANbus) channels.

Configuration Times - Sending scan data to the Pod

When starting a scan with large files there may be a considerable wait time while TCS sends the configuration data to the Pod. TCS may not issue any messages while configurations are being transmitted.

Digital Sensors

When a Digital Sensor is selected (either Period or Totalizer mode), the GPS Pulse Per Second (PPS) option must be disabled in both the Device Configuration and the Digital Pod configuration screens.

GPS Pulse Per Second (PPS) Issues

If the GPS sensor loses satellite lock during recording, the accuracy of synchronization functions that rely on Pulse Per Second (PPS) data may be affected and cannot be guaranteed. The typical drift when lock is lost is approximately 5 msec/hour. If GPS satellite lock is lost during recording, you should review the file if you are using PPS.

Selecting J1939 channels

When selecting J1939 channels, the check boxes that are enabled (selected) do not move with the associated channels if the channels are sorted.

Digital Pod Display

1. The Digital Pod Display will support up to 250 channels; any channel past that number is not displayed. Recording of digital data is not affected by this limitation.
2. When J1939 is selected on both CANbus ports, TCS will display all channels from Port 1 before displaying channels from Port 2.
3. If the Digital Pod Display screen is resized after scrolling to the bottom of a large list of values, the screen will not properly display all channels when you scroll back to the top. If this happens, switch away from the Digital Pod Display and then switch back again. This will refresh the screen and all channels will be displayed. Recording of digital data is not affected.

Digital Pod Configuration

Whenever the GPS/PPS option is enabled in the Digital Pod, PPS must also be enabled on the Device Configuration page. If the PPS option is not selected, PPS data exports will not increment as expected.

HDF files do not create separate GPS .csv files

When exporting a dataset with GPS data as an HDF file, TCS will not create a separate GPS .csv file. However, all other export formats will create a GPS .csv file when that option is selected in the 'GPS Options' screen.

Single Pod Monitor Display

1. When exponential notation is selected, clicking on a channel display will cause the channel to display in regular notation.
2. Exponential notation is not supported for Pseudo channels.

'Save as' restriction

When using "Save as.." you can not change directories with the browse function. Regardless where you choose to save the file (using the save as browse function), TCS will save the file in the TCS root path directory.

High Speed (HS) mode

Scan rates of 2400, 4800, & 9600 are not supported in older releases of TCS (prior to v3.1.7). Loading a test file with these rates into older TCS releases will reset the scan rate to 200 Hz.

Very High Speed (VHS) mode

1. Very High Speed mode is only supported on Titan II, Titan CAI, and Titan CPU08V devices. Using VHS mode with unsupported devices will result in TCS automatically switching to a lower speed mode or producing an error when attempting to scan.
2. Very High Speed mode is not supported in older releases of TCS (prior to v3.1.7)

Pseudo Channels

Pseudo channel functions that require the accumulation of data (such as averaging) will process as expected during scanning, however, the accumulation will restart anew when recording begins..

Inertial Measurement Unit (IMU) issues

Mars Labs' supplied 3DM IMU's are configured for a fixed data rate of 125 samples/second. This means that the selected scan rate in TCS must be set higher than 125s/s. Scan rates of less than 125 s/s will result in multiple IMU scans that will cause in discontinuities in the IMU data.

Hardware connection issues

Intermittent connections between Titan devices can result in phase shifts, offset shifts, and other odd behaviors observed in TCS. Users that experience phase shifts, timing errors, or offsets with CPU-connected hardware, or unreliable communication with any Titan device should first check the connections by twisting or wiggling connection wiring while scanning in TCS. Anomalies observed while checking this way typically indicate either faulty cabling or some type of intermittent connection failure. If faulty cabling is suspected, simply replace the cable and recheck the wiring while scanning. If no improvement is observed, the problem may be due to the device connector(s).

Equipment that is used in dusty or dirty environments can collect substances in open connectors, such as the RJ45 jacks in the Titan CPU or USB or serial port jacks in Titan Input Modules (Mini-Recorder and Pods). Although the routine insertion and extraction of connection cabling provides self-cleaning, it may not be sufficient to remove build-up on the contacts over time. If dirty contacts are suspected, the connector can be cleaned by applying contact cleaner, such as Techspray 1622-10S or equivalent, or by manually cleaning with cotton swabs dipped in high-concentration (99%) isopropyl alcohol. Regardless of the method used, **the procedure should be performed with the Titan device unplugged, and with cleaning products approved for electronics and electrical applications only. Additionally, no attempt should be made to scrape or scratch the contacts.** If the problem persists after cleaning the contacts, contact Mars Labs for further assistance.

Precautions:

Although Mars Labs is now supplying Titan hardware with connector dust caps to prevent the intrusion of dust and dirt, it is recommended that current Titan users cover unused connectors when the device is used in high dust/dirt environments. If connector dust caps are not available, exposed connectors can be protected with small bits of painters tape or any tape that doesn't leave a residue when removed (electrical tape or duct tape is not recommended for this application).

Titan Service Pack

The Titan Service Pack includes five useful utilities to assist with commonly used Titan operations such as firmware updates and IP address changes, the import/export of channel data, GPS data conversion into KML, and dataset decimation. The Titan Service Pack includes:

Titan CPU Firmware Updater Interface - A firmware updater utility for the Titan CPU.

Titan CPU IP Address Programmer - Utility for changing the IP address of the Titan CPU.

Excel - TCS Converter - Enables the transfer of channel data located on the TCS 'Tags & Channels' screen to/from an Excel spreadsheet.

Titan GPS to KML Exporter - Converts TCS GPS data in .CSV format to .KML (Keyhole Markup Language), permitting display of geographic data in an Earth browser such as Google Earth.

Titan Dataset Decimator - A utility that decimates sensor data on selected dataset channels.

The Titan Service Pack is available free of charge for all Titan users. Download the Titan Service Pack from the Mars Labs Knowledge Base:

<http://wiki.marslabs.com/doku.php>

Appendix A: Power and Sensor Configurations for Titan Pod & Mini-Recorder Hardware

This section provides information on power and common sensor connections.

Auxiliary Power Connector

The Auxiliary Power Connector is used to power the Titan devices for remote applications, or whenever sensor excitation voltages are enabled. The connector pinout is shown below. The voltage applied to Pin 2 (V+) is the recommended operating voltage of the device (a label on the side of the device near the power connector displays the operating voltage and connector pinout).

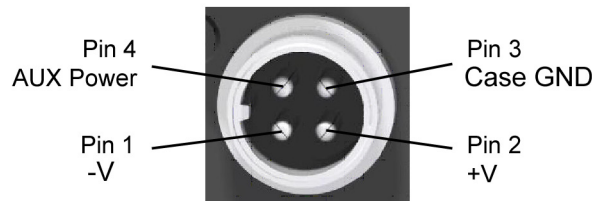

For Titan BMS devices the Aux Power voltage applied to Pin 4 is distributed to pin 5 on all input connectors (does not apply to Titan BSG or BDF devices). Aux Power can be used as an additional excitation or control source.

WARNING: When using an external power source with a Titan device, always make the connection to the device before applying power. Never hot plug a device under any circumstances - hot plugging may damage the device!

NOTE: The mating connector for 4-pin Auxiliary Power input is available from the following sources:

Mars Labs - P/N MLCON10227

Description: 4-Pin Female CB and HAM Radio Microphone Plug

Radio Shack - P/N 274-001

Description: 4-Pin Female CB and HAM Radio Microphone Plug

Westlake Electrical Supply - P/N T609B

Description: 4-Pin Inline Female Mobile Connector

For more information on Titan Device Power, refer to Applications Note APN-1005 - Titan Device Power

Full Bridge Sensor:

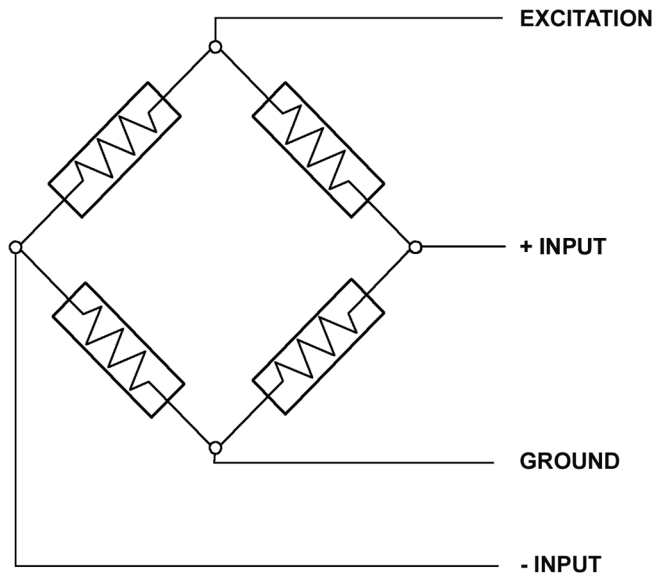

DB9 Connector:

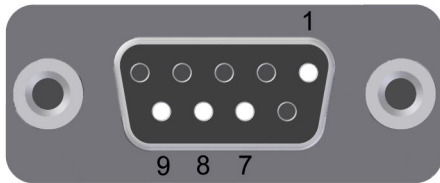

Bendix Connector:

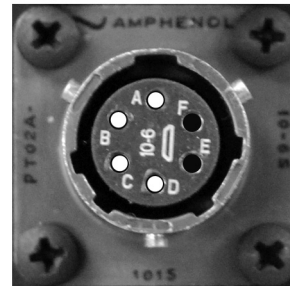

<i>Pin Assignment</i>	<i>Function</i>
1	Ground
2	QB Completion Resistor
3	Current source
4	ICP Capacitor
5	Auxiliary Voltage
6	Half Bridge Bias
7	- Input
8	+ Input
9	Programmable Excitation

<i>Pin Assignment</i>	<i>Function</i>
A	Programmable Excitation
B	+ Input
C	- Input
D	Ground
E	QB Completion Resistor
F	Half Bridge Bias

NOTE: For Full Bridge configurations, the Input Dividers are disabled.

See Strain Sensor configuration (pg 60)

See Load Sensor configuration (pg56)

Half Bridge Sensor:

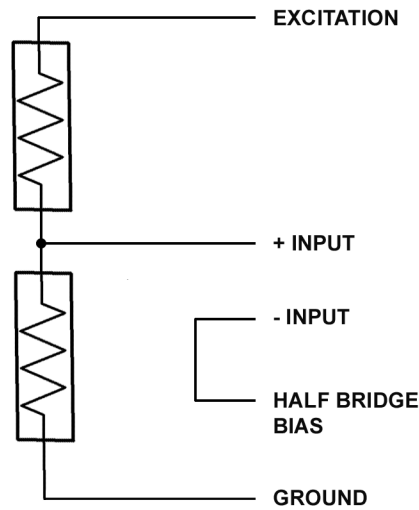

DB9 Connector:

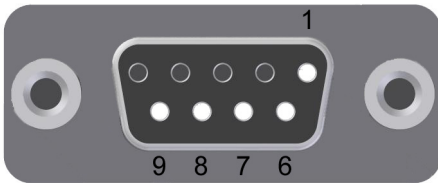

Bendix Connector:

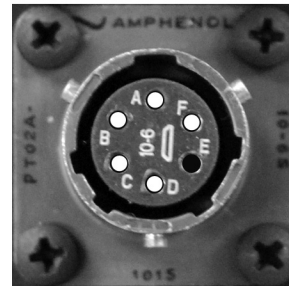

<i>Pin Assignment</i>	<i>Function</i>
1	Ground
2	QB Completion Resistor
3	Current source
4	ICP Capacitor
5	Auxiliary Voltage
6	Half Bridge Bias
7	- Input
8	+ Input
9	Programmable Excitation

<i>Pin Assignment</i>	<i>Function</i>
A	Programmable Excitation
B	+ Input
C	- Input
D	Ground
E	QB Completion Resistor
F	Half Bridge Bias

NOTE: For Half Bridge configurations, the Input Dividers are disabled.

Quarter Bridge Sensor:

DB9 Connector Wiring:

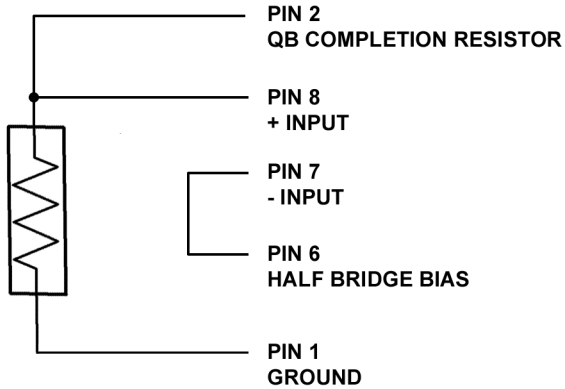

Bendix Connector Wiring:

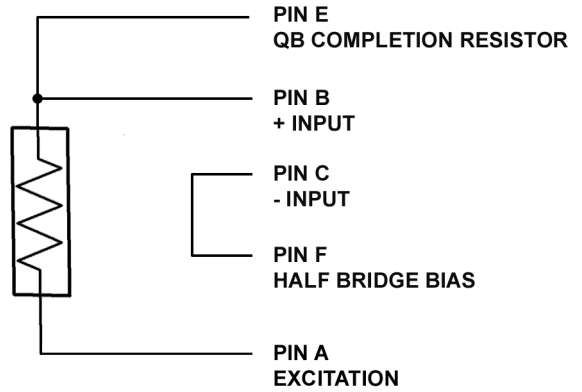

DB9 Connector:

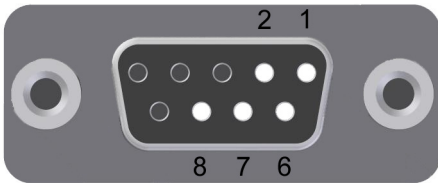

Bendix Connector:

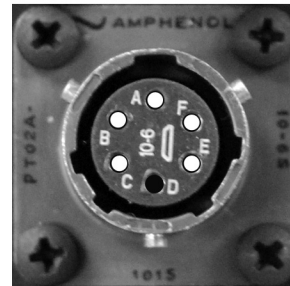

<i>Pin Assignment</i>	<i>Function</i>
1	Ground
2	QB Completion Resistor
3	Current source
4	ICP Capacitor
5	Auxiliary Voltage
6	Half Bridge Bias
7	- Input
8	+ Input
9	Programmable Excitation

<i>Pin Assignment</i>	<i>Function</i>
A	Programmable Excitation
B	+ Input
C	- Input
D	Ground
E	QB Completion Resistor
F	Half Bridge Bias

NOTE: For Quarter Bridge configurations, the Input Dividers are disabled.

Voltage Sensor:

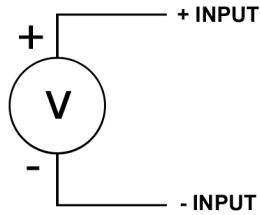

DB9 Connector:

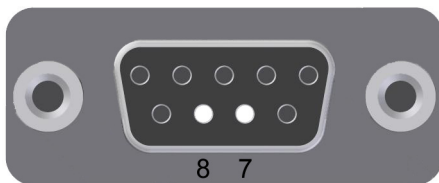

<i>Pin Assignment</i>	<i>Function</i>
1	Ground
2	QB Completion Resistor
3	Current source
4	ICP Capacitor
5	Auxiliary Voltage
6	Half Bridge Bias
7	- Input
8	+ Input
9	Programmable Excitation

Bendix Connector:

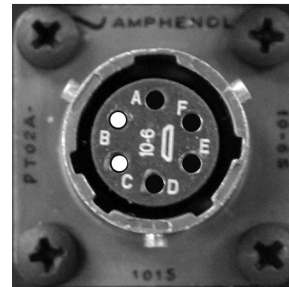

<i>Pin Assignment</i>	<i>Function</i>
A	Programmable Excitation
B	+ Input
C	- Input
D	Ground
E	QB Completion Resistor
F	Half Bridge Bias

NOTE: For Voltage Sensor configurations, the input dividers must be ON.

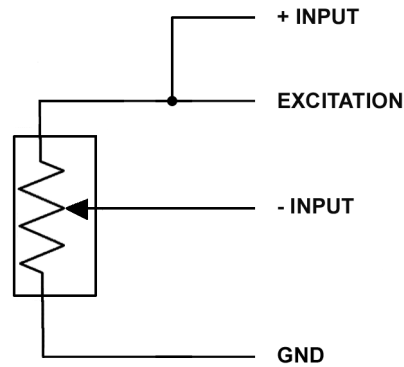
String Pot Sensor (Cable Extension Transducer):

DB9 Connector:

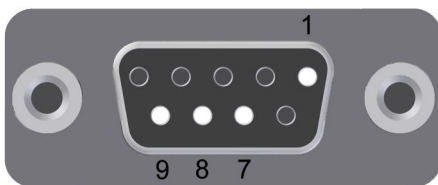

<i>Pin</i>	<i>Function</i>
1	Ground
2	QB Completion Resistor
3	Current source
4	ICP Capacitor
5	Auxiliary Voltage
6	Half Bridge Bias
7	- Input
8	+ Input
9	Programmable Excitation

Bendix Connector:

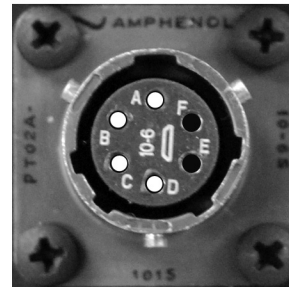

<i>Pin</i>	<i>Function</i>
A	Programmable Excitation
B	+ Input
C	- Input
D	Ground
E	QB Completion Resistor
F	Half Bridge Bias

NOTE: For String Pot configurations, the input dividers must be OFF.

RVIT (Rotary Variable Inductive Transducer), 60 Degrees:

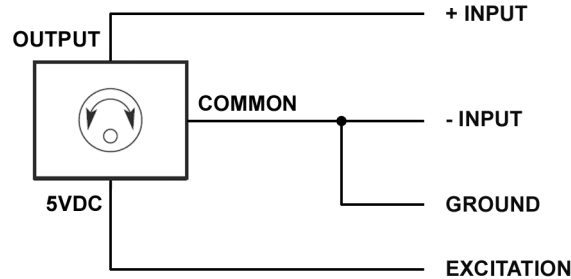

DB9 Connector:

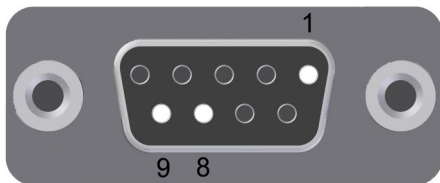

Bendix Connector:

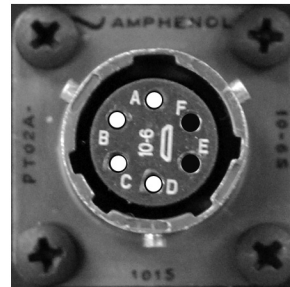

<i>Pin Assignment</i>	<i>Function</i>
1	Ground
2	QB Completion Resistor
3	Current source
4	ICP Capacitor
5	Auxiliary Voltage
6	Half Bridge Bias
7	- Input
8	+ Input
9	Programmable Excitation

<i>Pin Assignment</i>	<i>Function</i>
A	Programmable Excitation
B	+ Input
C	- Input
D	Ground
E	QB Completion Resistor
F	Half Bridge Bias

NOTES:

1. For RVIT configurations, the input dividers must be ON.
2. The configuration shown above is for the Schaevitz Sensors Model RVIT-15-60. For other RVIT sensors, consult the manufacturer's data sheet

Frequency Sensor - Generator:

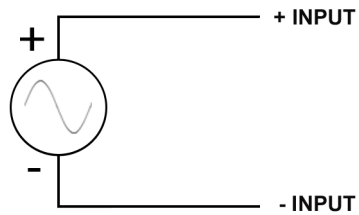

For Frequency Sensor inputs:
 TCS GAIN > 4
 Input signal > 4Vpp

DB9 Connector:

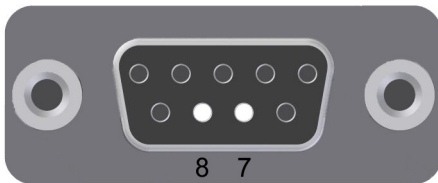

Bendix Connector:

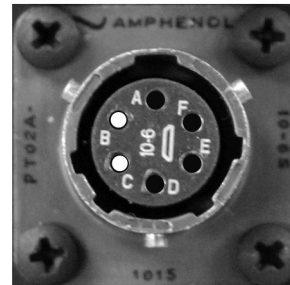

<i>Pin</i>	<i>Function</i>
1	Ground
2	QB Completion Resistor
3	Current source
4	ICP Capacitor
5	Auxiliary Voltage
6	Half Bridge Bias
7	- Input
8	+ Input
9	Programmable Excitation

<i>Pin</i>	<i>Function</i>
A	Programmable Excitation
B	+ Input
C	- Input
D	Ground
E	QB Completion Resistor
F	Half Bridge Bias

NOTES:

1. Frequency sensors are only supported on channels 1, 8 and 16; only one frequency sensor may be used at a time.
2. When a Frequency Sensor is used, the GPS Pulse Per Second (PPS) option must be disabled in both the Device Configuration and the Digital Pod configuration screens in TCS.
3. Frequency sensor measurements are valid to approximately 7 KHz

Frequency Sensor - Switch Closure:

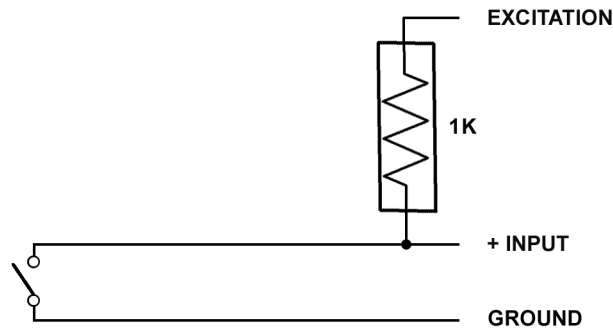

DB9 Connector:

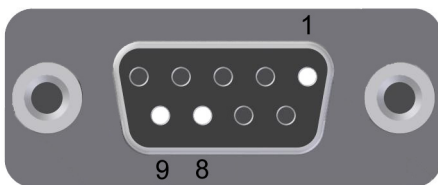

Bendix Connector:

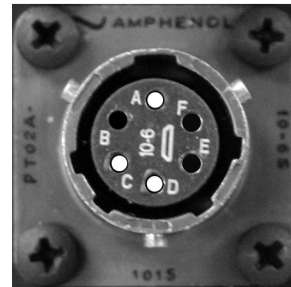

<i>Pin Assignment</i>	<i>Function</i>
1	Ground
2	QB Completion Resistor
3	Current source
4	ICP Capacitor
5	Auxiliary Voltage
6	Half Bridge Bias
7	- Input
8	+ Input
9	Programmable Excitation

<i>Pin Assignment</i>	<i>Function</i>
A	Programmable Excitation
B	+ Input
C	- Input
D	Ground
E	QB Completion Resistor
F	Half Bridge Bias

NOTES:

1. Frequency sensors are only supported on channels 1, 8 and 16; only one frequency sensor may be used at a time.
2. Frequency sensors measurements are valid to approximately 7 KHz

Thermocouple Sensor:

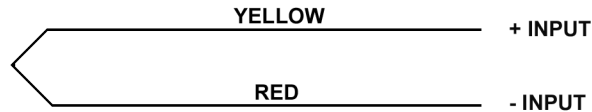

DB9 Connector:

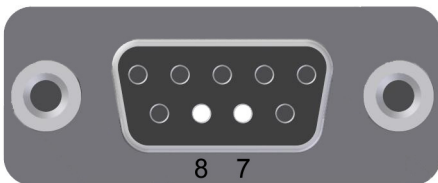

<i>Pin Assignment</i>	<i>Function</i>
1	Ground
2	QB Completion Resistor
3	Current source
4	ICP Capacitor
5	Auxiliary Voltage
6	Half Bridge Bias
7	- Input
8	+ Input
9	Programmable Excitation

Bendix Connector:

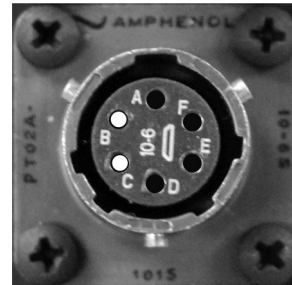

<i>Pin Assignment</i>	<i>Function</i>
A	Programmable Excitation
B	+ Input
C	- Input
D	Ground
E	QB Completion Resistor
F	Half Bridge Bias

NOTES:

1. The colors displayed above are for a Type K thermocouple.
2. Titan Input Modules with firmware versions earlier than 0.27.3 require a 100K resistor connected between the + Input (pin 8) and Excitation (pin 9).

ICP Sensor:

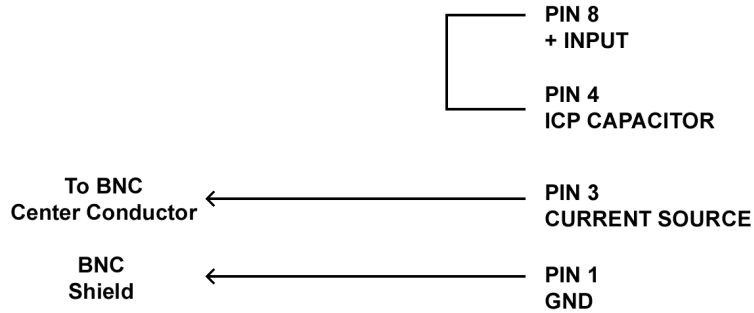

DB9 Connector:

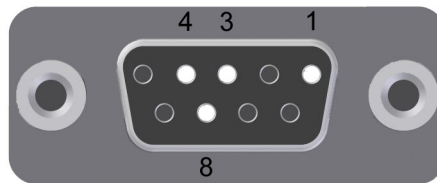

<i>Pin Assignment</i>	<i>Function</i>
1	Ground
2	QB Completion Resistor
3	Current source
4	ICP Capacitor
5	Auxiliary Voltage
6	Half Bridge Bias
7	- Input
8	+ Input
9	Programmable Excitation

NOTES:

- For ICP configurations, current = 2.5mA
- Titan BMS devices provide an ICP capacitor on pin 4 and should be wired as shown. Older Titan AMS devices did not provide an internal ICP capacitor on pin 4; this capacitor had to be added externally between pin 8 and pin 3. Titan ICP DB9/BNC adapters originally made for AMS devices included a capacitor between pins 3 and 8; these adapters can be used without modifications on Titan BMS devices.

Dytran Sensor:

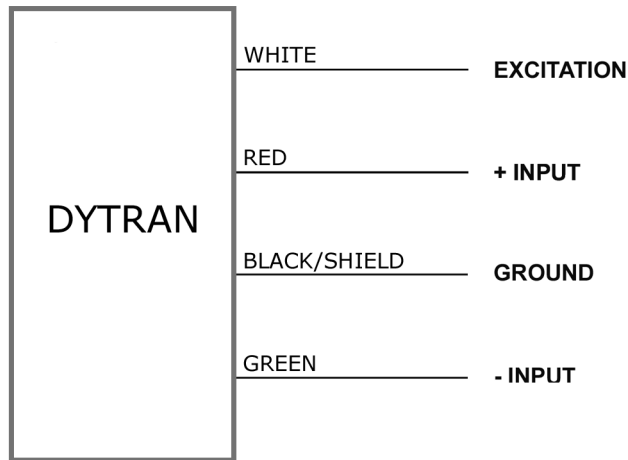

DB9 Connector:

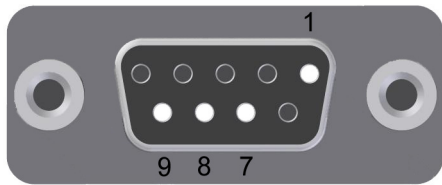

Bendix Connector:

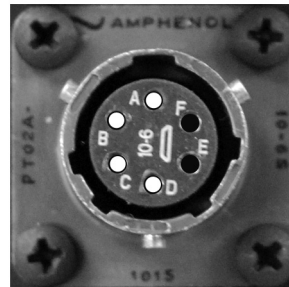

<i>Pin Assignment</i>	<i>Function</i>
1	Ground
2	QB Completion Resistor
3	Current source
4	ICP Capacitor
5	Auxiliary Voltage
6	Half Bridge Bias
7	- Input
8	+ Input
9	Programmable Excitation

<i>Pin Assignment</i>	<i>Function</i>
A	Programmable Excitation
B	+ Input
C	- Input
D	Ground
E	QB Completion Resistor
F	Half Bridge Bias

NOTE: For Solid State Accelerometer configurations, Input Dividers are disabled.

See Accelerometer Sensor configuration (pg 52)

Microphone (Condenser):

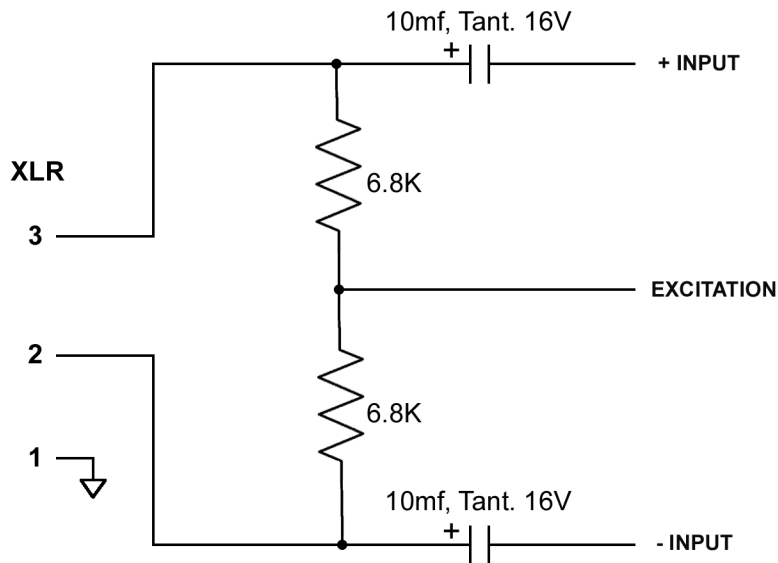

DB9 Connector:

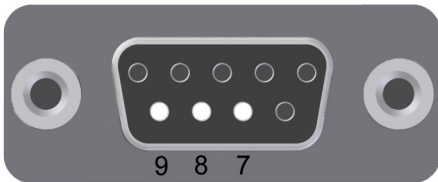

Bendix Connector:

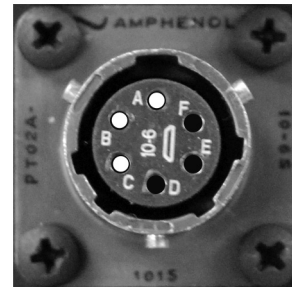

<i>Pin Assignment</i>	<i>Function</i>
1	Ground
2	QB Completion Resistor
3	Current source
4	ICP Capacitor
5	Auxiliary Voltage
6	Half Bridge Bias
7	- Input
8	+ Input
9	Programmable Excitation

<i>Pin Assignment</i>	<i>Function</i>
A	Programmable Excitation
B	+ Input
C	- Input
D	Ground
E	QB Completion Resistor
F	Half Bridge Bias

NOTES: 1. Adjust excitation for 11.5V
2. Input Dividers must be ON

Appendix B: Scan Rates and Supported Configurations

The Scan Rate drop down on the Device Configuration screen provides three ranges of available operating rates: Low, High, and Very High Speed Modes.

Low Speed Mode provides a range of 10 to 1200 samples per second per channel. The available Low Speed rates are:

10, 20, 32, 40, 50, 64, 80, 100, 128, 200, 204.8, 300, 400, 409.6, 512, 600, 1024, and 1200.

High Speed Mode provides a range of 128 to 10,000 samples per second per channel. The available High Speed Rates are:

128, 200, 204.8, 250, 256, 400, 409.6, 500, 512, 1000, 1024, 2000, 2048, 2400*, 2500, 4000, 4800*, 5000, 8000, 8192, 9600*, and 10K.

NOTE: *Sample rates marked with an asterisk (*) are only available on Titan devices with firmware version 0.34.20 or higher installed.*

Very High Speed Mode provides a range of 11,025 to 60,000 samples per second per channel. Available Very High Speed Rates are:

11.025K, 20K, 22.050K, 25K, 30K, 40K, 44.1K, 48K, 50K, and 60K.

NOTE: *For all speeds, the Filter Frequency parameter sets the frequency of the anti-aliasing filter. For High Speed and Very High Speed Modes, the filter is automatically set to 0.49 of the selected scan rate. For Low Speed Mode, the filter is selectable; the available frequencies are: Bypassed, 5, 10, 20, 40, 50, 80, 100, 150, 200, 230, and 250 Hz.*

All Titan High Speed devices support Low Speed and High Speed operation, although not at every available scan rate. Refer to the Data Sheet or User Manual of the respective device for a list of supported rates. Very High Speed (VHS) rates only apply to Titan II, Titan CAI, and Titan CPUxxV devices. If you attempt to connect to devices that do not support VHS mode, TCS will automatically switch to a lower speed mode, but leave all other test configurations unaffected. A few Titan devices, such as older Titan CPU08 and CPX Expanders, will allow you to connect at the selected VHS rate, but will issue an error if you attempt to scan.

Maximum Configurations

A single Titan Input Module supports up to 16 analog channels, plus digital channels. For a single module, the operational performance is largely determined by the speed of the serial connection link, which dictates the maximum sample rate and the maximum number of supported channels. Likewise, the speed of the connection link imposes the same limitations on the maximum sample rate and number of supported channels when Titan Channel Expanders and/or Titan Expanders are used to create larger channel-count systems.

In use, Titan CPU Channel Expanders with RJ-45 connectors set all serial connections to 3M. For a Titan model CPU08, for example, this connection speed will support up to 8 Input Modules (128 analog channels total) at 2500 samples/second, with sufficient bandwidth left to support a single GPS or Digital Pod. This combination of modules, channels, and sample rate represents a maximum system configuration. Attempting to run this system at a higher sample rate will result in errors because the amount of additional data generated will exceed the ability of the system to transfer the data over the 3M serial link. Thus, the speed of the connection link ultimately places limitations on the size of the test system, the maximum sample rate, and the maximum number of supported channels.

Since the speed of the connection link is static and unchangeable, trade-offs can be made in other areas to gain more channels or attain higher sample rates depending on the test requirements.

Although the system size, sample rate, and number of channels can be freely selected in TCS, the software offers no assistance to configuring optimal test systems that will work within throughput limits. TCS currently places no restrictions on the selection of configuration parameters based on prior selections, and this can result in test system configurations that are incompatible with the serial link limit. Mars Labs is aware of the issue and is considering a number of possible improvements to TCS that will aid the end user. Until such time that a solution becomes available, the following is offered for guidance in creating large channel-count test systems:

MAXIMUM SUPPORTED CHANNELS BY SCAN RATE																				
TITAN CHANNEL MULTIPLEXER:	VERY HIGH SPEED		11.025K - 50K		60K															
	CML (w/C-series Input Modules only)		80		64															
	HIGH SPEED		128 - 2500		4000		4096		4800		5000		8000		8192		9600		10K	
	CPU08		128		64		48		32		32		N/A		N/A		N/A		N/A	
CPU08V		128		128		128		128		128		128		104		(8 modules at 13 channels each)				
TITAN EXPANDERS	VERY HIGH SPEED		11.025K		16K		20K - 30K		40K - 44.1K		48K - 50K		60K							
	CML w/CMX04 Pod Expanders		320		256		128		96		72		64							
	HIGH SPEED		128 - 1024		2000		2048 - 5000		8000 - 10K											
	CPX03 Expander w/CPU08		384		256		N/A		N/A											
CPX03 Expander w/CPU08V		384		384		256		N/A												

NOTES:

1. Values shown are for systems configured exclusively with analog sensors.
2. For all CPU and Expander configurations, each connected Input Module should have approximately the same number of channels assigned. Configurations that are not balanced in this manner may not support the stated maximum number of channels for a given scan rate and may exhibit reduced performance or, in extreme instances, result in data drops.

Additional Considerations for Systems that include GPS or Digital Pod

When GPS or Digital Pod data is included as a part of the acquisition, the additional data loading can impose further limitations on the maximum size of the system. The following configurations are offered for guidance in optimized large channel-count systems:

Titan model CPU08:

For Analog + GPS configurations -

128 channels [8 modules (16 ch/pod) + 1 GPS] - 2500 s/s max

64 channels [4 modules (16 ch/pod) + 1 GPS] - 4000 s/s max

32 channels [2 modules (16 ch/od) + 1 GPS] - 5000 s/s max

For Analog + Digital Pod (2 CAN + IMU + GPS) configurations -

128 channels [8 modules (16 ch/pod) + 1 DP] - 2500 s/s max

56 channels [3 modules (16 ch/pod) + 1 module (8/ch) w/DP] - 4000 s/s max

24 channels [1 modules (16 ch) + 1 module (8/ch) w/DP] - 5000 s/s max

Titan model CPU08V:

For Analog + GPS configurations -

128 channels [8 modules (16 ch/pod) + 1 GPS] - 5000 s/s max

118 channels [7 modules (16 ch/pod) + 1 module (6/ch) w/GPS] - 8192 s/s max

97 channels [7 modules (13 ch/pod) + 1 module (6ch) w/GPS] - 10,000 s/s max

For Analog + Digital Pod (2 CAN + IMU + GPS) configurations -

128 channels [8 modules (16 ch/pod) + 1 DP] - 2500 s/s max

56 channels [3 modules (16 ch/pod) + 1 module (8/ch) w/DP] - 5000 s/s max

Appendix C: Changing the CAN mode

The Digital Pod supports both ISO CAN and non-ISO CAN protocols. **The factory default setting is ISO CAN.** Any CAN port can be switched between ISO CAN and non-ISO modes using the following procedure. Note that there are two preamble commands (**STEP 3** below) that must always be issued **BEFORE** issuing the change mode commands. Once changed, the new mode will be persistent thru power cycles.

For devices directly-connected via USB (standalone operation):

1. Launch TCS and Connect [F1] to the Titan device.
2. In TCS, select [F10] 'Manual Command'
3. In the Manual Command window, enter:

```
SET_AUX_BAUD_RATE 1843200<CR>
TCS will respond with an acknowledgement (ACK)
AUX GET_SW_VERSION<CR>
TCS will respond with the current software version.
These commands prepare the device for the CAN port mode change.
```
4. To set a CAN port for 'ISO OFF' (non-ISO), enter:

```
AUX SET_CAN1_NISO 1<CR> (for CAN1)
... up to ...
AUX SET_CAN6_NISO 1<CR> (for CAN6)
```
5. To set a CAN port for 'ISO ON' (ISO), enter:

```
AUX SET_CAN1_NISO 0<CR> (for CAN1)
... up to ...
AUX SET_CAN6_NISO 0<CR> (for CAN6)
```
6. To check the setting for a given port, enter:

```
AUX GET_CAN1_NISO<CR>
... up to ...
AUX GET_CAN6_NISO<CR>
```

The value that is returned indicates the current mode ('0' = ISO, '1' = non-ISO)

For devices connected to a Titan CPU Channel Expander (system configuration):

1. Launch TCS and Connect [F1] to the Channel Expander
2. In TCS, select [F10] 'Manual Command'
3. In the Manual Command window, enter:

```
SET_PORT X <CR> where 'X' is the port number of the connected device.
Note that you must place a space before the value 'X' in the command
For a 12-Port Channel Expander, valid input values are 1 thru 12
```
4. With the desired port selected, enter the preamble commands from step 3 above for directly-connected devices and follow the remaining steps.

This page intentionally left blank

Appendix D: TCS Changelog

This section lists the history of major changes and enhancements to TCS

V3.3.23 – [1/10/24]

- Included 250Hz filter and 230Hz filter.
TCS no longer allows selection of filters equal to ½ the scan rate.

V3.3.21 - [9/4/23]

- Added FD CAN checkbox for each CAN Port
- Added GX3/GX5 IMU choice dropdown
- Support for U-Blox GNSS messages
- Added 3-port and 6-port suppression checkboxes

V3.3.19 - [2/7/23]

- Adds support for up to 6 CAN ports
- Corrects an issue with exporting big endian CAN data

V3.3.17 - [1/25/22]

- Updated for compatibility with older (non-CAN_FD) Digital Pods

V3.3.15 - [6/21/21]

- Updated for compatibility with the CAN FD Digital Pod

V3.3.14 - [6/21/21]

- Corrected an issue with the Multiple Pod Monitor screen where it did not correctly display the realtime data of more than 7 Pods.

V3.3.12 - [3/12/21]

- Corrected a scaling issue with Titan CAI devices in Titan CPU-based configurations (see also ‘Note & Known Issues - CPU Configuration’, page156)

V3.3.11 - [9/4/20]

- Corrected a configuration issue where a Digital Pod could not be enabled in a new test if a previous test had a Digital Pod enabled (Service Bulletin 2413).

V3.3.9 - [6/22/20]

- Corrected export scaling for CAI devices.

V3.3.8 - [3/31/20]

- Updated for Federal Information Processing Standards (FIPS) compatibility.

V3.3.7 - [6/5/19]

- Implemented additional navigation key short-cuts in the In-Vehicle Display (IVD)
- Improved IVD screen graphics for small monitors.
- Corrected error on IVD launch that caused the file path to break.

V3.3.5 - [8/9/18]

- Added 'Concatenated Recording' option on the Recordings & Triggers screen.
- Added Single Channel Export option ('Select on Export').
- Added 'Auto-Start' option on the Device Configuration screen.
- Updated the IMU Euler Angle display
- Changed the Displacement Sensor default condition to Input Dividers OFF
- Implemented Helper Icons
- Modified the In-Vehicle Display panel to improve readability on small screens

V3.3.4 - [2/22/18]

- Added option to TCS Settings to disable Monitor Mode in CPU configurations.

V3.3.3 - [11/20/17]

- Corrected method of calculating the HDF5 export path so that the launch of the HDF5 reviewer will see the generated file even if the .tdf file had been renamed outside of TCS.
- When enabled, CPU Monitor Mode is highlighted yellow with a message indicating that the modules are no longer synchronized by the CPU clock.
- Added serial data rates for CAI pods.
- Implemented a prototype WFT-based speed on the In-Vehicle Display targeting an averaged speed from all 4 wheels (~ 5Hz update rate).
- Added a lockout with message if more than one pod selects the digital pod.
- Implemented 'File Renaming' feature (see page 127).

V3.3.2 - [1/19/17]

- Added speed support for the Titan CAI Mini-Recorder
- Added 'Pascals' & 'PSI' unit options to Engineering Units
- Customized the Engineering Units drop-down menu to display the units appropriate for the chosen sensor.
- TCS User Manual - Added 'Hardware Connection Issues' to Notes & Known Issues section

V3.3.1 - [10/24/16]

- Implemented multiple review windows in the Export tab
- Changed 'Very High Speed' mode selection to be available only for Titan II devices
- Permit subsection selections in the FFT Reviewer window to be exported as separate TDF files
- Add the ability to display no channels in Multi-Plot review screens
- Corrected an issue in the Single and Multiple Pod Monitor screens where Frequency Sensor data was displayed as having exceeded peak values (as indicated by a red color) when the data was still within acceptable limits.
- Added tiling of HDF5 reviewer windows when opening from the Export panel.
- Corrected an issue where the HDF5 reviewer failed to launch in the Export reviewer.
- Implemented WAVIEEE export file format (allows transform-scaled data to be viewed in standard PC sound applications)
- Implemented HDF5 Multi-Plot reviewer capability to run on 64-bit machines
- Added initial 24-bit analog data stream support
- Initial implementation of a new 'Test Control' screen to the In-Vehicle Display

V3.3.0 - [3/31/16]

- Added high precision, double based HDF5 export supporting high precision location data
- Corrected calibration issue with digital gains (256 & 512)
- Implemented Demo Mode
- Deleted 'MODE' dropdown on the Load sensor screen
- Corrected FFT channel dropdown issue on the Export screen
- Added Help link function key [F12]
- TCS User Manual - Added accelerometer sensor and condenser wiring diagrams

V3.1.9 - [1/6/15]

- Implemented Error Logging
- Added 'Error' hyperlink to the Export screen and anchored 'Export' and 'Error' hyperlinks to new location.
- Enabled File Partitioning for CPU and CPX devices
- Increased the number of samples for the Capture function from 30K to 1.2M.
- Improved the responsiveness to the 'Get Info' request for the CPX Expander.

V3.1.8 - [8/12/15]

- Added Poisson's Ratio data entry field to the Strain Sensor Type (entry field is not currently implemented)
- Added 'Default Display' checkbox to 'Tags & Channels' screen

V3.1.7 - [5/28/15]

- Implemented Multi-Plot Data Review
- Added Very High Speed Scan Rate selection for Titan II devices
- Added inverted gain selections
- Added note on WFT configurations (pg 86)
- Fixed 'blank screen' error that occurred when loading a configuration file that was not located in the Mars Labs directory
- Corrected export issue with CPU GPS/PPS data

V3.1.6 - [4/23/15]

- Improved GPS sync performance on files with dropped PPS pulses
- Added acknowledgement (ACK) enable function to Digital Pod configuration window

V3.1.0 [7/1/14]

- Added three additional scan rates (2400, 4800 and 9600 Hz) to High-Speed mode. If the pod does not support the chosen scan rate, an error will be reported when scanning is attempted.
- Allowed Titan CPU to be set to scan rates of 8000, 8192, 9600 and 10,000 Hz.
- Increased the maximum number of pods supported to 64 (1024 channels total).
- Changed Single Pod Monitor screen to display up to 16 Pseudo Channels.
- Added overload indication to the Single Pod Monitor screen.
- Added support for sending Trigger Alarm Outputs to GPIOs on supported Titan devices (currently only the Titan Mini-CPU).
- Changed the parsing of the NEMA GPS \$GPRMC message to recognize 3 digits after the decimal point in the timestamp.
- Set the initial gain of thermocouple sensors to 64.
- Fixed bug where accelerometer sensor excitation value changes back to 2.048V when editing the sensor settings.
- Fixed bug parsing DBC files with extra spaces.
- Fixed bug parsing big endian CAN data.
- Fixed bug that caused Bit Length values to not display in J1939 editor.
- Corrected problem sending large .tcf files to Mini-Recorder.
- Fixed bug that caused all file dates on the CPU to appear to be created in the current year.
- Fixed bug that caused Titan CPU files created more than 6 months ago to not appear in the 'Browse Remote Files' list.
- Fixed bug where "Incomplete Scan" would be erroneously reported when exporting a .tdf file.

Appendix E: Titan Firmware Changelog

This section lists the history of major changes and additions to the Titan High Speed Firmware. For optimum performance, Titan Input Modules should always have the latest firmware installed unless otherwise directed by Mars Labs (see Service Bulletins).

V0.34.31 - Released 8/17/23

No Service Bulletin issued

- Update for EDP09 Digital Pod
- Support of U-Blox GPS

V0.34.29 - Released 9/18/18

No Service Bulletin issued

- Update to enable both GX3 and GX5 IMU on the AUX Digital Input port.

V0.34.28 - Released 8/6/18

No Service Bulletin issued

- Implemented IMU support on the AUX Digital Input Port (AKA GPS Port)

V0.34.27 - Not Released

V0.34.26 - Released 3/31/16

Service Bulletin SB-2355

- Implemented corrective measures to mitigate potential issues in the event of electrostatic discharge (ESD)
- Corrected a calibration issue at high gain setting (256 & 512) when CAL+ or CAL - was enabled
- Added thru-the-device firmware updating capability for Mini-Recorders with Internal Digital Pods

V0.34.24 - V0.34.25 - Not Released

V0.34.23 - Released 7/27/15

Service Bulletin SB-2329

- Improved the throughput of devices that include an Internal Digital Pod
- Corrected issues affecting positive and negative gain settings (256 & 512) identified in SB-2325-1
- Corrected a data synchronization issue that occurred when Mini-Recorders with different firmware versions (v0.34.18 and earlier, and v0.34.20 and later) were connected to a Titan CPU. The issue involved a 6-scan skew between devices running in High Speed mode. The skew only occurred the first time the system was run after power up; it did not occur on subsequent runs.
- Corrected an issue introduced in v0.34.20 dealing with high speed scans over a serial connection (RJ45 Comm Port).

V0.34.20 - Released 5/28/15

Service Bulletin SB-2322

Service Bulletin SB-2325-1 (bug identified in V0.34.20)

- Implemented inverted gain support (provides polarity inversion - supported in TCS v3.1.7 and higher)
- Added support for 2400, 4800, and 9600 scan rates
- Improved Digital Pod throughput for large data files
- Increased Thermocouple normalization time (removes stepped response at scan startup)

V0.34.19 - Not Released

V0.34.18 - Released 4/23/15

Service Bulletin SB-1277

- Update guarantees that the 3 GPS NMEA messages contain the same timestamp.

V0.34.17 - Not Released

V0.34.16 - Released 11/26/14

Service Bulletin SB-2297

- Provides improved noise performance on channels 1 and 15
- Implemented clock output support for USB-based CPUs.

V0.34.15 - Not Released

V0.34.14 - Beta - Released 11/4/14

No Service Bulletin issued

- Implemented clock output support for USB-based CPUs.

V0.34.13 - Not Released

V0.34.12 - Released 4/4/14

Service Bulletin SB-2255

- Corrects an issue where the Thermocouple type is incorrectly set when scanning is initiated by engaging the Record switch or by using AutoRecord
- Added support for the Titan Mini-DAC expansion card

V0.34.1 - V0.34.11 - Not Released

V0.34.0 - Released 7/18/13

No Service Bulletin issued

- Corrects an issue where the Thermocouple type is incorrectly set when scanning is initiated by engaging the Record switch or by using AutoRecord.

Appendix F: Acknowledgements

This section acknowledges the software libraries and utilities used in TCS in order to comply with licensing and copyright requirements.

ZedGraph Lesser General Public License (LGPL) notice:

ZedGraph Class Library - A Flexible Line Graph/Bar Graph Library in C#
Copyright (C) 2004 John Champion

This library is free software; you can redistribute it and/or modify it under the terms of the GNU Lesser General Public License as published by the Free Software Foundation; either version 2.1 of the License, or (at your option) any later version.

This library is distributed in the hope that it will be useful, but WITHOUT ANY WARRANTY; without even the implied warranty of MERCHANTABILITY or FITNESS FOR A PARTICULAR PURPOSE. See the GNU Lesser General Public License for more details.

A copy of the full LGPL license and the source code is located in the TCS install directory.

HDF5DotNet Software Library and Utilities Copyright Notice and License:

HDF5 (Hierarchical Data Format 5) Software Library and Utilities
Copyright 2006-2013 by The HDF Group.

NCSA HDF5 (Hierarchical Data Format 5) Software Library and Utilities
Copyright 1998-2006 by the Board of Trustees of the University of Illinois.

All rights reserved.

Redistribution and use in source and binary forms, with or without modification, are permitted for any purpose (including commercial purposes) provided that the following conditions are met:

1. Redistributions of source code must retain the above copyright notice, this list of conditions, and the following disclaimer.
2. Redistributions in binary form must reproduce the above copyright notice, this list of conditions, and the following disclaimer in the documentation and/or materials provided with the distribution.
3. In addition, redistributions of modified forms of the source or binary code must carry prominent notices stating that the original code was changed and the date of the change.
4. All publications or advertising materials mentioning features or use of this software are asked, but not required, to acknowledge that it was developed by The HDF Group and by the National Center for Supercomputing Applications at the University of Illinois at Urbana-Champaign and credit the contributors.

5. Neither the name of The HDF Group, the name of the University, nor the name of any Contributor may be used to endorse or promote products derived from this software without specific prior written permission from The HDF Group, the University, or the Contributor, respectively.

DISCLAIMER: THIS SOFTWARE IS PROVIDED BY THE HDF GROUP AND THE CONTRIBUTORS “AS IS” WITH NO WARRANTY OF ANY KIND, EITHER EXPRESSED OR IMPLIED. In no event shall The HDF Group or the Contributors be liable for any damages suffered by the users arising out of the use of this software, even if advised of the possibility of such damage.

Contributors: National Center for Supercomputing Applications (NCSA) at the University of Illinois, Fortner Software, Unidata Program Center (netCDF), The Independent JPEG Group (JPEG), Jean-loup Gailly and Mark Adler (gzip), and Digital Equipment Corporation (DEC).

Portions of HDF5 were developed with support from the Lawrence Berkeley National Laboratory (LBNL) and the United States Department of Energy under Prime Contract No. DE-AC02-05CH11231.

Portions of HDF5 were developed with support from the University of California, Lawrence Livermore National Laboratory (UC LLNL). The following statement applies to those portions of the product and must be retained in any redistribution of source code, binaries, documentation, and/or accompanying materials:

This work was partially produced at the University of California, Lawrence Livermore National Laboratory (UC LLNL) under contract no. W-7405-ENG-48 (Contract 48) between the U.S. Department of Energy (DOE) and The Regents of the University of California (University) for the operation of UC LLNL.

DISCLAIMER: This work was prepared as an account of work sponsored by an agency of the United States Government. Neither the United States Government nor the University of California nor any of their employees, makes any warranty, express or implied, or assumes any liability or responsibility for the accuracy, completeness, or usefulness of any information, apparatus, product, or process disclosed, or represents that its use would not infringe privately- owned rights. Reference herein to any specific commercial products, process, or service by trade name, trademark, manufacturer, or otherwise, does not necessarily constitute or imply its endorsement, recommendation, or favoring by the United States Government or the University of California. The views and opinions of authors expressed herein do not necessarily state or reflect those of the United States Government or the University of California, and shall not be used for advertising or product endorsement purposes.

Binding List View License & Notice:

Copyright (c) 2006, Andrew Davey
All rights reserved.

Redistribution and use in source and binary forms, with or without modification, are permitted provided that the following conditions are met:

1. Redistributions of source code must retain the above copyright notice, this list of conditions and the following disclaimer.
2. Redistributions in binary form must reproduce the above copyright notice, this list of conditions and the following disclaimer in the documentation and/or other materials provided with the distribution.

DISCLAIMER: THIS SOFTWARE IS PROVIDED BY THE COPYRIGHT HOLDERS AND CONTRIBUTORS "AS IS" AND ANY EXPRESS OR IMPLIED WARRANTIES, INCLUDING, BUT NOT LIMITED TO, THE IMPLIED WARRANTIES OF MERCHANTABILITY AND FITNESS FOR A PARTICULAR PURPOSE ARE DISCLAIMED. IN NO EVENT SHALL THE COPYRIGHT OWNER OR CONTRIBUTORS BE LIABLE FOR ANY DIRECT, INDIRECT, INCIDENTAL, SPECIAL, EXEMPLARY, OR CONSEQUENTIAL DAMAGES (INCLUDING, BUT NOT LIMITED TO, PROCUREMENT OF SUBSTITUTE GOODS OR SERVICES; LOSS OF USE, DATA, OR PROFITS; OR BUSINESS INTERRUPTION) HOWEVER CAUSED AND ON ANY THEORY OF LIABILITY, WHETHER IN CONTRACT, STRICT LIABILITY, OR TORT (INCLUDING NEGLIGENCE OR OTHERWISE) ARISING IN ANY WAY OUT OF THE USE OF THIS SOFTWARE, EVEN IF ADVISED OF THE POSSIBILITY OF SUCH DAMAGE.

The views and conclusions contained in the software and documentation are those of the authors and should not be interpreted as representing official policies, either expressed or implied, of the FreeBSD Project.

This page intentionally left blank

